



[www.bmtmedikal.com.tr](http://www.bmtmedikal.com.tr)



## Ürün Katalođu

“sađlık teknolojisindeki son nokta”



[www.bmtmedikal.com.tr](http://www.bmtmedikal.com.tr)

## ÜRÜNLERİMİZ

- HASTABAŞI MONİTÖRLERİ
- EKG CİHAZLARI
- PULSEOKSİMETRELER
- FETAL MONİTÖRLER
- ENJEKTÖR POMPALARI
- İNFÜZYON POMPALARI
- KÜVÖZ VE FOTOTERAPİ
- DEFİBRİLATÖRLER
- İNVAZİV KABLolar, İBP KABLolar
- ELEKTRO KOTER AKSESUARLARI
- İSİ PROBLARI
- EKG KABLO , EKG LEAD
- SPO2 PROB
- SPO2 KABLO
- NİBP MANŞON , ADAPTOR ve HORTUMLARI
- OKSİJEN SENSÖRLER, FLOW SENSÖRLER
- VENTİLATÖRLER
- ANESTEZİ CİHAZLARI
- NEMLENDİRİCİLER
- VENTİLATOR AKSESUARLARI



## Misyon

BMT MEDİKAL olarak misyonumuz, meslek ahlaki ile sosyal sorumluluğunun bilincinde deneyimli ve güçlü teknik servis ekibiyle ameliyathane ve yoğun bakım cihazları başta olmak üzere tüm tıbbi cihazlara teknik servis ve z hizmeti vermek. Tüm uygulamalarında bilimsel etik ilkeleri benimseyerek uygulamak ve bu doğrultuda “referans bir şirket” olma özelliği sürdürmek.



www.bmtmedikal.com.tr

## Vizyon

İhtiyaçlarınızı takip ederek, modern çağın yüksek standartlardaki ürünlerini, insan sağlığı ve müşteri memnuniyeti temeline esas alarak, uluslararası kalite standartlarında çözüm ortaklığı yapmak. Bu amaç doğrultusunda, verdiğimiz hizmetleri, en yüksek kalitede, kanıta dayalı ve standart olarak sunmayı hedefliyoruz.

## Müşteri Memnuniyeti ve Kararlılık

Şirketimiz için, en önemli başarı göstergelerinden biri müşteri memnuniyetidir. Bunun için, bizden hizmet alan müşterilerimizin memnuniyetini sistemli olarak izleyecek ve elde ettiğimiz sonuçları, sunduğumuz hizmetleri geliştirmekte kullanıyoruz. Müşterilerimize karşı en önemli sorumluluklarımızdan biri olarak da, maliyetlerimizi ve verimliliğimizi etkin olarak yönetip, yüksek kalitemizden ödün vermeden, hizmetlerimizin uygun fiyatlarla sunulmasını sağlamaktır.

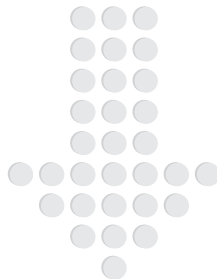

# BPS 510

BP-S510, kullanıcı dostu bir çalışma sağlar sofistike bir tasarıma sahiptir. Gelişmiş işlevselliği, anestezi sonrası bakım, acil cerrahi, endoskopi, acil servis ve daha fazlasını içeren geniş bir kullanım çeşitliliği için mükemmel yapar.



- 10,4" yüksek çözünürlüklü TFT ekran
- 4-6 dalga formu, Büyük yazı tipi,
- Tüm parametrelerin 24 saatlik nümerik ve tablo trend özelliği
- Hastanenin tüm alanlarında kullanım imkanı
- Hafif ve kopmak tasarım
- Yetişkin, Pediatrik ve Yeni doğan kullanım
- Dahili Batarya
- Merkezi monitör sistemine bağlantı imkanı
- Güçlü işlevler ile Dijital izleme
- Düşük güç tüketimi ve düşük arıza oranı
- Ani güç kaybından sonra otomatik kaydetme
- Ağ işlevi Standart: EKG, Resp, NIBP, SpO2, TEMP, HR
- Opsiyonel: Printer, çift TEMP, ETCO2, Tek \ Çift IBP
- Nellcor SPO2 teknolojisi.
- Colin NIBP teknolojisi.

MONİTÖRLER

www.bmtmedikal.com.tr



# HBP 2070

- 7 inç yüksek çözünürlüklü TFT ekran
- Transportta kullanılabilir, bataryalı
- 3 dalga formu, Büyük yazı tipi,
- Yetişkin, Pediatrik ve Yeni doğan kullanım
- Güçlü işlevler ile Dijital izleme
- Düşük güç tüketimi ve düşük arıza oranı
- Ani güç kaybından sonra otomatik kaydetme
- Ağ işlevi Standart: EKG, Resp, NIBP, SpO2, TEMP, HR
- Nellcor SPO2 teknolojisi.
- Colin NIBP teknolojisi.

# T 105

- Yüksek hızlı" kan basıncı ,Monitör HBP-T105 işlevi , personel için zaman kazandırır stresi azaltır ve hasta konforunu artırır
- Otomatik olarak hasta için daha rahat bir ölçüm deneyim sonuçlar, kontrol eder.
- Sesli alarm sesleri gibi sorunlar ortaya çıktığında ölçüm görsel bir gösterge görüntüler.
- Otomatik zamanlanmış kan basıncı ölçümleri
- Alınan son 400 ölçümleri saklar.
- Tek bir düğmeye basit bir itme ile, önceki ölçümleri gözden geçirebilirsiniz.
- NIBP ölçümü etkinleştirmek için bir ana buton.
- Ölçümleri okumak için, ekran ergonomik pozisyonu.
- Kan basıncı almak için bir düğme operasyonu
- Yeni COLIN kan basıncı modülü Yüksek Hızda fonksiyonu ile donatılmıştır
- Herhangi bir çaba olmadan kolay görüntüleme için yenilikçi 40 derece açılı görüntüleme,
- Nellcor SPO2 teknolojisi.
- Colin NIBP teknolojisi

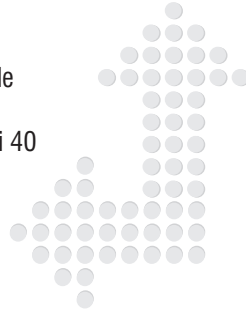

# EKG 406İ

- 4.3 inç yüksek çözünürlüklü TFT ekran
- 3/6 Kanal kayıt yapabilme yorumlu EKG

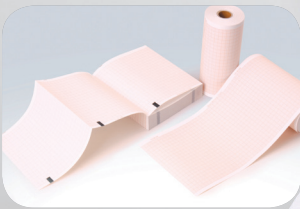

# iM50

## MONİTÖRLER



- 8,4" renkli TFT-LCD ekran
- Fansız soğutma sistemi
- Dokunul ve yapılandırın: Kişisel çalışma özel parametre tıklayarak veya yapılandırmak için dalga formu
- Kalp pili algılama
- Elektro girişim kanıtı
- Defibrilasyon koruması ve defibrilasyon senkronizasyon
- Derece tonu (Darbe-ton modülasyonu)
- Hangi Benzersiz iSEAP algoritması özel aritmi hastaları için optimize edilmiştir
- Çift modlu anti-parazit nabız oksimetre
- SP10 Onaylanmış NIBP
- Rahat ölçüm deneyimi (isteğe bağlı) için Akıllı Enflasyon teknolojisi ile Omron M3600 NIBP
- USB / SD depolama
- Hemşire çağrı fonksiyonu
- VGA çıkışı (Isteğe bağlı)
- XML dosyaları ile HL7 desteği
- Isteğe bağlı Wi-Fi özelliği ile LAN bağlantısı

# iM70

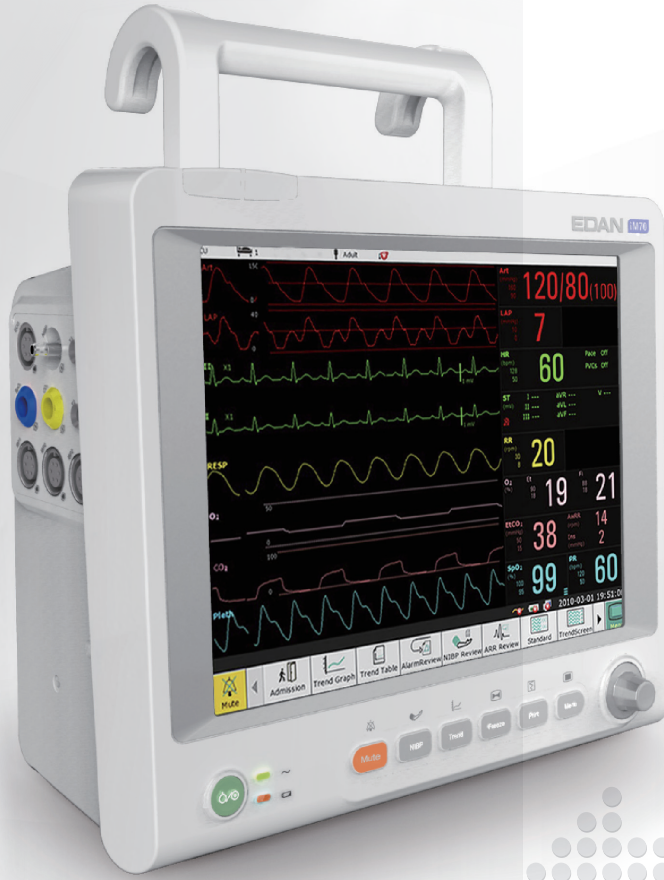

www.bmtmedikal.com.tr

- 12.1" renkli TFT-LCD ekran geniş 11 kanal dalga formu
- Fansız soğutma sistemi
- Dokunun ve yapılandırın: Kişisel çalışma özel parametre tıklayarak veya yapılandırmak için dalga formu
- Kalp pili algılama
- Elektro girişim kanıtı
- Defibrilasyon koruması ve defibrilasyon senkronizasyon
- Derece tonu (Darbe-ton modülasyonu)
- Hangi Benzersiz iSEAP algoritması özel aritmi hastaları için optimize edilmiştir
- Çift modlu anti-parazit nabız oksimetre
- SP10 Onaylanmış NIBP
- Rahat ölçüm deneyimi (isteğe bağlı) için Akıllı Enflasyon teknolojisi ile Omron M3600 NIBP
- USB / SD depolama
- Hemşire çağrı fonksiyonu
- VGA çıkışı (İsteğe bağlı)
- XML dosyaları ile HL7 desteği
- İsteğe bağlı Wi-Fi özelliği ile LAN bağlantısı
- Yetişkin için uygun pediatrik ve neonatal hastalarla uyumlu

# iM80

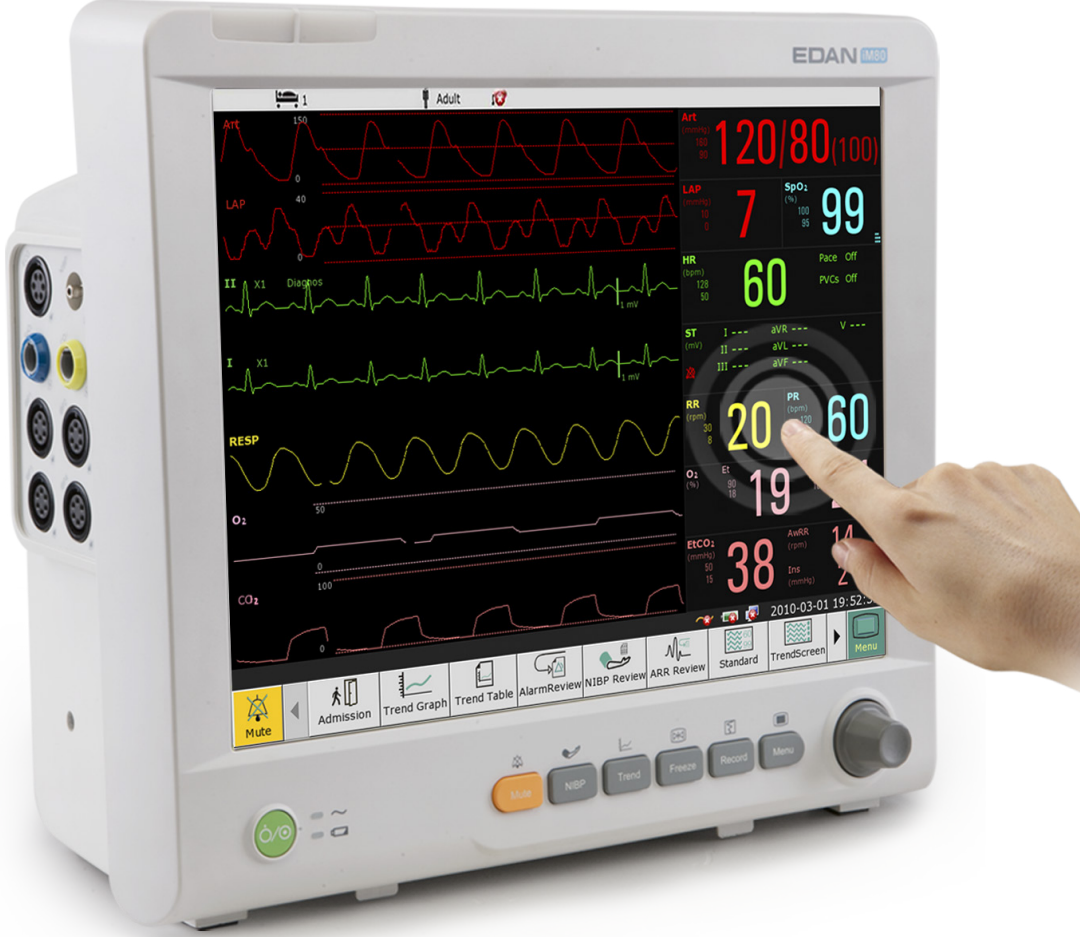

MONİTÖRLER

www.bmtmedikal.com.tr

- 15" renkli TFT-LCD ekran geniş 11 kanal dalga formu
- Fansız soğutma sistemi
- Dokunun ve yapılandırın: Kişisel çalışma özel parametre tıklayarak veya yapılandırmak için dalga formu
- Kalp pili algılama
- Elektro girişim kanıtı
- Defibrilasyon koruması ve defibrilasyon senkronizasyon
- Derece tonu (Darbe-ton modülasyonu)
- Hangi Benzersiz iSEAP algoritması özel aritmi hastaları için optimize edilmiştir
- Çift modlu anti-parazit nabız oksimetre
- SP10 Onaylanmış NIBP
- Rahat ölçüm deneyimi (isteğe bağlı) için Akıllı Enflasyon teknolojisi ile Omron M3600 NIBP
- USB / SD depolama
- Hemşire çağrı fonksiyonu
- VGA çıkışı (Isteğe bağlı)
- XML dosyaları ile HL7 desteği
- Isteğe bağlı Wi-Fi özelliği ile LAN bağlantısı
- Yetişkin için uygun pediatrik ve neonatal hastalarla uyumlu

# F3 FETAL MONİTÖR



www.bmtmedikal.com.tr

## Özellikler

### Fiziksel Karakteristikler

Boyutlar: 350 mm x 300 mm x 104 mm  
Ağırlık: Ortalama 3.5 kg

### Ekran Özellikleri

Ekran: 5.6" renkli TFT-LCD  
Çözünürlük: RGB 640 (W) x 480 (H)

### Ultrason

Teknik: Otokorelasyonlu Ultrason Puls Dopler  
Puls Tekrarlama Oranı: 2 kHz  
Ultrason Frekansı: (1.0 ± %10) MHz  
FHR Ölçüm Aralığı: 50 bpm~240 bpm  
Çözünürlük: 1 bpm  
Doğruluk: ±2 bpm  
/ob: <10 mW/cm<sup>3</sup>

### DECG

Teknik: Pik-pik tespit tekniği  
DFHR Ölçüm Aralığı: 30 bpm ~ 240 bpm  
Çözünürlük: 1 bpm  
Doğruluk: ± 1 bpm

### TOCO

TOCO Aralığı: %0- %100  
Lineer Olmayan Hata: ≤%10  
Çözünürlük: %1  
Sıfır Modu: Otomatik / Manüel

### IUP

Basınç Aralığı: 0~ 100 mm Hg  
Lineer Olmayan Hata: ≤±3 mm Hg  
Çözünürlük: %1  
Sıfır Modu: Otomatik / Manüel

## FETAL MONİTÖR



- 10.2" yüksek çözünürlüklü renkli TFT ekran
- 12 kristalli su geçirmez FHR prop
- Düz yüzeyli su geçirmez TOCO prop
- Opsiyonel maternal parametre monitorizasyonu
- Uzun ömürlü dahili termal yazıcı
- Standart termal kağıtlar ile kullanım
- Dahili şarj edilebilir batarya



# FETAL TRANSDUCERS



HP/Philips  
Ultrasound

Compatible monitors:  
1350A, Viridia Series 50 XM  
Comes in a button and clip style  
(button style pictured)

OEM P/N: M1356A  
AIV P/N: FM10835

Connector  
RED



HP/Philips  
Tocodynamic

Compatible monitors:  
M1350A, Viridia Series 50 XM  
Comes in a button and clip style  
(clip style pictured)

OEM P/N: M1355A  
AIV P/N: FM10841

Connector  
TAN

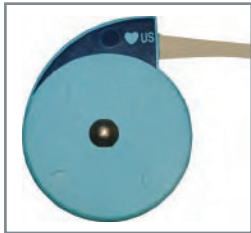

GE/Corometrics  
Ultrasound  
Water Resistant

Compatible monitors:  
116, 118, 120, 340 Tel

OEM P/N: 5700 LAX (belt style)  
5700 HAX (button style)

AIV P/N: FM10833 (belt style)  
FM10834 (button style pictured)

Connector  
BLUE



GE/Corometrics  
Tocodynamic  
Water Resistant

Compatible monitors:  
115, 116, 118, 120, 145, 150, 151, 155, 340 Tel

OEM P/N: 2264 LAX (belt style)  
2264 HAX (button style)  
AIV P/N: FM10839 (belt style pictured)  
FM10840 (button style)

Connector  
WHITE

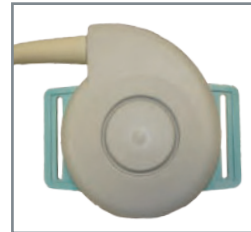

# 601 C

## EKG CİHAZLARI



### Kullanıcı Dostu Tasarım

- Kompakt ve kolay taşınabilir tasarım
- Dokunmatik Renkli LCD Ekran
- Alfanumerik klavye

### Kolaylaştırılmış İş Akışı

- Cinsiyet ve yaş gurubu seçimleri için belirlenmiş kısa yollar
- Kolay hasta kaydı için barkod okuyucu ve tarayıcı özellik

### Doğru ve Hızlı Klinik Performansı

- 12 kanal eş zamanlı işlem
- Kaliteli ve doğru sinyal algılaması için anti gürültü teknolojileri ve filtre sistemleri
- Cinsiyet ve yaş seçimlerinde akıllı otomatik analiz
- CSE/AHA/MIT Otomatik ölçüm ve yorumlama
- Aritmi ve normal dışı atım tespitinde otomatik çekim süresi uzatma

### Geliştirilmiş Farklı ve Kaliteli Baskı Formatları

- Dahili Yüksek Çözünürlüklü 200 dpi termal yazıcı
- Harici USB yazıcı desteği

### Veri ve hasta Kaydı

- 2 Dahili 200 hasta kaydı ve opsiyonel SD Kart okuyucu bağlantı özelliği
- Bilgisayar ve veri ağına bağlantı için opsiyonel PC yazılım

### Bağlantı Özellikleri

- LAN/WiFi Üzerinden bilgisayara data aktarımı
- Standart ECG formatları: PDF ve opsiyonel SCP/ FDA-XML/DICOM data aktarımı
- DMS özelliği ile çift yönlü veri iletişimi



## CARDIOLINE

### arview EKG SERİLERİ

Cardioline'da, zengin özelliklere sahip, yüksek kaliteli ve uygun fiyatlı tek başına çalışan EKG cihazları serileri mevcuttur ve bunlar küçük taşınabilir versiyonlar ile hastane için tam boyutlu üniteler arasında değişir:

- ar600view – 3 kanal EKG
- ar1200view – 6 kanal EKG
- ar2100view – 12 kanal EKG

Kişiselleştirilebilir raporlar ile yüksek çözünürlüklü termal yazıcı

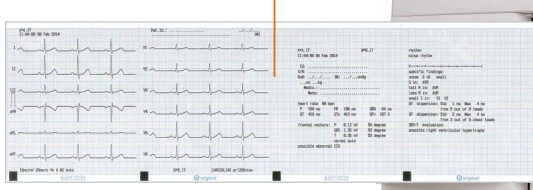

Data transferi için Entegre Bluetooth



- 100 ila 200 incelemenin içeride depolandığı hafıza seçeneği;
- İsbetli ve eksiksiz otomatik teşhis özellikleri için değerlendirme seçeneği;
- Bilgisayarlara kolay ve hızlı veri transferi için entegre Bluetooth;
- Tamamen kişiselleştirilebilir basılı raporlar;
- Kağıtsız operasyonlar, oto-zamanlı baskı, Bilgisayar-EKG modu.

	microtel	ar600view	ar1200view	ar2100view
<b>Hafıza</b>	75	100	200	200
<b>Klavye</b>	Birleşik	Birleşik	Standart	Gelişmiş
<b>Yazıcı</b>	yok	3 kanal	6 kanal	12 kanal
<b>Kağıt</b>	yok	60 mm	110 mm	Tam sayfa

12 LEAD'e kadar gözlemlemek için açık renkli TFT ekranı

Manuel, Otomatik veya programlanabilir mod

Belirlenmiş fonksiyon tuşları olan yumuşak klavye

#### Klavye

Alfanumerik klavye sayesinde kullanıcılar, hastanın demografik verilerini kolayca düzenleyebilir ve sistemki hızlıca kurabilir.

Dahili Ağır İş Bataryası

#### Gerçek Zamanlı Bilgisayar-EKG fonksiyonu

Entegre Bluetooth bağlantısı sayesinde, arview familyasındaki cihazlar, cubecg yazılımı kullanılarak, EKG incelemelerini gerçek zamanlı olarak bir bilgisayara direkt olarak kaydetmek için kullanılabilir.

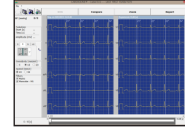

## PC EKG CİHAZLARI

### HD+ akizisyon ünitesi

Cardioline'ın yeni HD+ yüksek performans akizisyon ünitesi, modern bir dizaynı sınıf özelliklerinin en yüksek kalitesiyle birleştirir.

- 12-LEAD kablolu BT akizisyon ünitesi;
- AAMI ve AHA uyumlu, yüksek kalite, düşük sesli EKG sinyali;
- Her kanalda 1000 Hz'e kadar, 24 bit örnekleme frekansı;
- Her kanalda 32000 Hz örnekleme frekansında, eşsiz pacemaker belirleme;
- Tek tuşla aşırı kolay operasyon;
- IPX4 toz ve sıvı koruması, darbe dayanıklı;
- Bir çift AAA pil ile 500'den fazla kayıt;

HD+, sabit EKG incelemeleri ve EKG inceleme stres testleri yapmak için, touchecg, cubecg ve cubestress gibi Cardioline yazılım ürünleriyle kombinasyon halinde kullanılabilir.

Hafif IPX4 kapağı



Veri transferi için entegre Bluetooth

Akıllı eşleme teknolojisi

Standart AAA pil



	HD+	clickcg BT	clickcg USB
<b>Ağırlık</b>	90 gr	115 gr	100 gr
<b>Piller</b>	2 x AAA	2 x AA	USB
<b>Uyumluluk</b>	cubestress ve cubecg, touchecg	cubestress ve cubecg, touchecg	cubestress ve cubecg
<b>Koruma</b>	IPX4	IPX2	IPX2

### clickcg

clickcg standart EKG akizisyon üniteleri, BT veya USB bağlantı imkanına sahiptir. clickcg, HD+ ile aynı çalışma prensibine sahiptir;

- Kolay operasyon;
- Kompakt ve hafif;
- Daha uzun operasyon zamanı ile daha az enerji tüketimi;
- Hasta konforunu arttırmak amacıyla, bilgisayara kablo bağlantısı gerekmez (BT).



clickcg

# H 100 B

## PULSEOKSİMETRE

- LCD Ekran
- RTC (Gerçek Zamanlı Saat)Ekran
- Arka Ekran Işıığı ve Güç Tasarrufu İçin Otomatik Kapanma Fonksiyonu
- SpO2 ve Nabız Ölçümü
- Eş Zamanlı SpO2 Dalga Formu ve Numerik Gösterim
- Uzun Batarya Ömrü – 50 Saate Kadar
- Yüksek Kapasiteli veri Depolama
- Saklama Tekrar İzleme ve Yazdırım için Pc'ye Transfer
- Ekrandan Son 10 Dakikalık Nabız Atımı ve SpO2 Trend Grafiği İzleme
- Nellcor Sensör Uyumlu
- Nabız Sesi
- Sesli ve Görsel Alarm Kabiliyeti
- Otomatik kapanma
- Yetişkin / Pediatrik / Neonatal Mod Seçimi



# EEG KABLOLAR



- Mor
- Sarı
- Kırmızı
- Gri
- Mavi
- Siyah
- Beyaz
- Yeşil
- Pembe
- Turuncu
- Kahverengi
- Açık Mavi

[www.bmtmedikal.com.tr](http://www.bmtmedikal.com.tr)

tedavi'deki  
yardımcılarınız...

# SK 600 IB

Toplam İnfüzyonmiktarı	:1~9999ml
Doğruluk	:±5
KVO oranı	:1ml/h, (KVO) hız
İnfüzyonartışla	:1ml/h
Uygulanabilir infüzyonsetleri	: Set bağımsız
Uygulanabilir infüzyonhacmi	:1~9999ml
Batarya	:Şarj edilebilir lityum pil,7.4V 1650mAh
Alarm fonksiyonu	:İnfüzyon tamamlanması, tıkanıklığı, hava kabarcığı, düşük pil, anormal AC güç kaynağı, kurulum hatası.



# SN 50 F6

- Tüm marka enjektörler ile hatasız çalışabilme
- Aynı anda farklı akış hızlarında bağımsız iki kanal infüzyon
- 10, 20, 30, 50 mL kapasiteli enjektörler ile çalışabilme
- %2 den az hata oranı
- Otomatik enjektör kalibrasyonu
- 6 saat kullanılabilir şarj edilebilir dahili batarya
- 3 seviyeli tıkanıklık alarm limiti ayarlayabilme
- Basınç alarmı oluştuğunda otomatik olarak geri çekerek basınç düşürme
- KVO ve BOLUS fonksiyonu
- Gelişmiş görsel ve sesli uyarı sistemi
- 0,1 -1500 ml/saat aralığında infüzyon akış hızı ayarlayabilme
- Hedef hacim sınırlandırabilme
- Giden toplam hacim izleyebilme
- PC data aktarımı ve güncelleme için RS232 portu



# SN 50 C6



# SN 50 C6 T6



- Tüm marka enjektörler ile hatasız çalışabilme
- 10, 20, 30, 50 mL kapasiteli enjektörler ile çalışabilme
- %2 den az hata oranı
- Otomatik enjektör kalibrasyonu
- 6 saat kullanılabilir şarj edilebilir dahili batarya
- 3 seviyeli tıkanıklık alarm limiti ayarlayabilme
- KVO ve BOLUS fonksiyonu
- Gelişmiş görsel ve sesli uyarı sistemi
- 0,1 -1500 ml/saat aralığında infüzyon akış hızı ayarlayabilme
- Hedef hacim sınırlayabilme
- Giden toplam hacim izleyebilme
- PC data aktarımı ve güncelleme için RS232 portu
- 500 adet geçmiş bilgi kaydı
- Basınç alarmı oluştuğunda otomatik olarak geri çekerek basınç düşürme

- Tek Kanal Kullanım
- Digital panel
- Set Bağımsız , her marka enjektör ile uyumlu
- 6 Saat Dahili Batarya
- Tıkanıklık Alarmı
- 20-30-50 cc Kullanım
- Bolus Modu
- 0.1-1500 ml/h İnfüzyon Hızı
- KVO modu
- Anti bolus özelliği
- Hedef hacim ayarlayabilme



## YP-90 YOĞUN BAKIM KÜVÖZÜ

- \* Servo kontrollü hava modu
- \* Çift cidarlı kabin (opsiyonel)
- \* Dokunmatik membran tuş takımı
- \* Trendelenburg ve ters trendelenburg
- \* Gelişmiş alarm sistemi
- \* Röntgen kaseti koyma yeri (opsiyonel)
- \* Dahili bebek terazisi (opsiyonel)
- \* Uluslararası ISO ve CE belgeleri



KÜVÖZLER

## YP-90 A YOĞUN BAKIM KÜVÖZÜ

- \* Servo kontrollü hava ve cilt modu
- \* Çift cidarlı kabin (opsiyonel)
- \* Dokunmatik membran tuş takımı
- \* Dolaplı stand
- \* Trendelenburg ve ters trendelenburg
- \* Gelişmiş alarm sistemi
- \* Röntgen kaseti koyma yeri (opsiyonel)
- \* Elektronik yükseklik ayarı (opsiyonel)
- \* Dahili bebek terazisi (opsiyonel)
- \* Uluslararası ISO ve CE belgeleri



www.bmtmedikal.com.tr

# YP-970 YOĞUN BAKIM KÜVÖZÜ

- \* Servo kontrollü hava ve cilt modu
- \* Servo kontrollü nem ve oksijen modülleri
- \* Çift cidarlı kabin
- \* Dokunmatik membran tuş takımı
- \* Dolaplı stand
- \* Trendelenburg ve ters trendelenburg
- \* Gelişmiş alarm sistemi
- \* Röntgen kaseti koyma yeri (opsiyonel)
- \* Elektronik yükseklik ayarı (opsiyonel)
- \* Dahili bebek terazisi (opsiyonel)
- \* Uluslararası ISO ve CE belgeleri



www.bmtmedikal.com.tr

# XHZ 90L Led Fototerapi

YÜKSEK YOĞUNLUKLU LED FOTOTERAPİ

- \* Fototerapi süresini gösteren sayaç
- \* Başlık kısmı sağa sola – yukarı aşağı ayarlanabilir
- \* Yüksekliği ayarlanabilir
- \* Mobil ve her küvöze uygun
- \* Bebeğe üstten fototerapi tedavisi uygulanabilir
- \* Küvöz üzeri kullanım özelliği
- \* 5000 saat LED ömrü
- \* Kolay Taşınabilme
- \* Küvöz dışında fototerapi tedavisi uygulayabilme
- \* Dört tekerlekli



# YOĞUN BAKIM ÇÖZÜMLERİ

## (yetişkin / adult)

### VENTILATÖRLER

#### TEKNİK BİLGİLER

Patient type  
Ventilation settings  
Ventilation mode

Adult, Pediatric, Neonatal (optional)

- IPPV, IPPV<sub>assist</sub> (CMV, CMV<sub>assist</sub>)
- SIMV, SIMV<sub>ASB</sub> (SIMV, SIMV/<sub>Psupp</sub>)
- MMV, MMV<sub>ASB</sub> (MMV, MMV/<sub>Psupp</sub>)
- BIPAP<sup>1)</sup>, BIPAP<sup>1)</sup><sub>ASB</sub>, BIPAP<sup>1)</sup><sub>Assist</sub> (PCV+, PCV+/<sub>Psupp</sub>, PCV+<sub>Assist</sub>)
- APRV
- CPAP, CPAP<sub>ASB</sub> (CPAP, CPAP/<sub>Psupp</sub>)
- ILV
- PPS (optional)\*

Enhancements

- AutoFlow™ – Automatic adaptation of inspiratory flow in volume controlled modes
- ATC™ – Automatic Tube Compensation (optional)



# (yenidođan / neonatal)



[www.bmtmedikal.com.tr](http://www.bmtmedikal.com.tr)



# BELLAVISTA

mbar

40  
20  
0

10

20

30

mbar

50  
30  
20  
10  
0

Ramp 15 %

$P_{Insp} + PEEP$  25 mbar

ExhSe

$T_{Insp}$  1.7 s

2

3

$T_{Exp}$  3.3 s

Mode  
PC-  
SIMV

$P_{Insp}$   
20  
mbar

$P_{Support}$   
25  
mbar

PEEP  
5  
mbar

Rate  
12  
bpm

$T_{Insp}$   
1.7  
s



### Single Vent • Settings

ens 75 %

$P_{\text{Support}} + \text{PEEP}$  30 mbar

Press. Trig. 2.1 mbar

PEEP 5 mbar

$T_{\text{Cyd}}$  5.0 s

4 5 6

Mode

- PCV
- P-A/C
- PC-SIMV ✓
- PSV
- VCV
- V-A/C

Cancel

Apply

Trigger Press. 2.1 mbar

Press. Trig. 2.1 mbar

ExhSens 75 %

Ramp 15 %



# BELLAVISTA

Connectors on the right side

**Inspiration connector**  
Inspiration outlet to patient

**Speaker**  
Multimedia sound speaker

**O<sub>2</sub> cell**  
O<sub>2</sub> cell cover



www.bmtmedikal.com.tr



bellavista



Ventilation



Doctor Cockpit

## Connection Assist • Right

of bellavista 1000

### USB stick

USB stick for logging and data exchange

### Info button

Press button to show this explanation

### SpO<sub>2</sub> pulse oxymeter connector

Sensor connection

### CO<sub>2</sub> sensor connector

Sensor connection

### Exp. valve

Control pressure port for expiration valve

### Proximal flow

Secondary port for proximal flow measurement (white tube)

Primary port for proximal flow measurement (blue tube)

### Pressure measurement

Measurement port for proximal pressure

www.bmtmedikal.com.tr



Monitoring



Settings



Alarm Settings



# HER MARKA VE MODEL AMELİYATHANE DONANIMLARI

**SAĐLIĐINIZ İÇİN HER ZAMAN  
EN İYİSİNİ DÜŐÜNÜRÜZ...**

**SON MODEL GELİŐMİŐ  
TIBBİ CİHAZLAR**



# OKSİJEN SENSÖRLERİ



## Oxygen Sensors



# FLOW SENSÖRLERİ

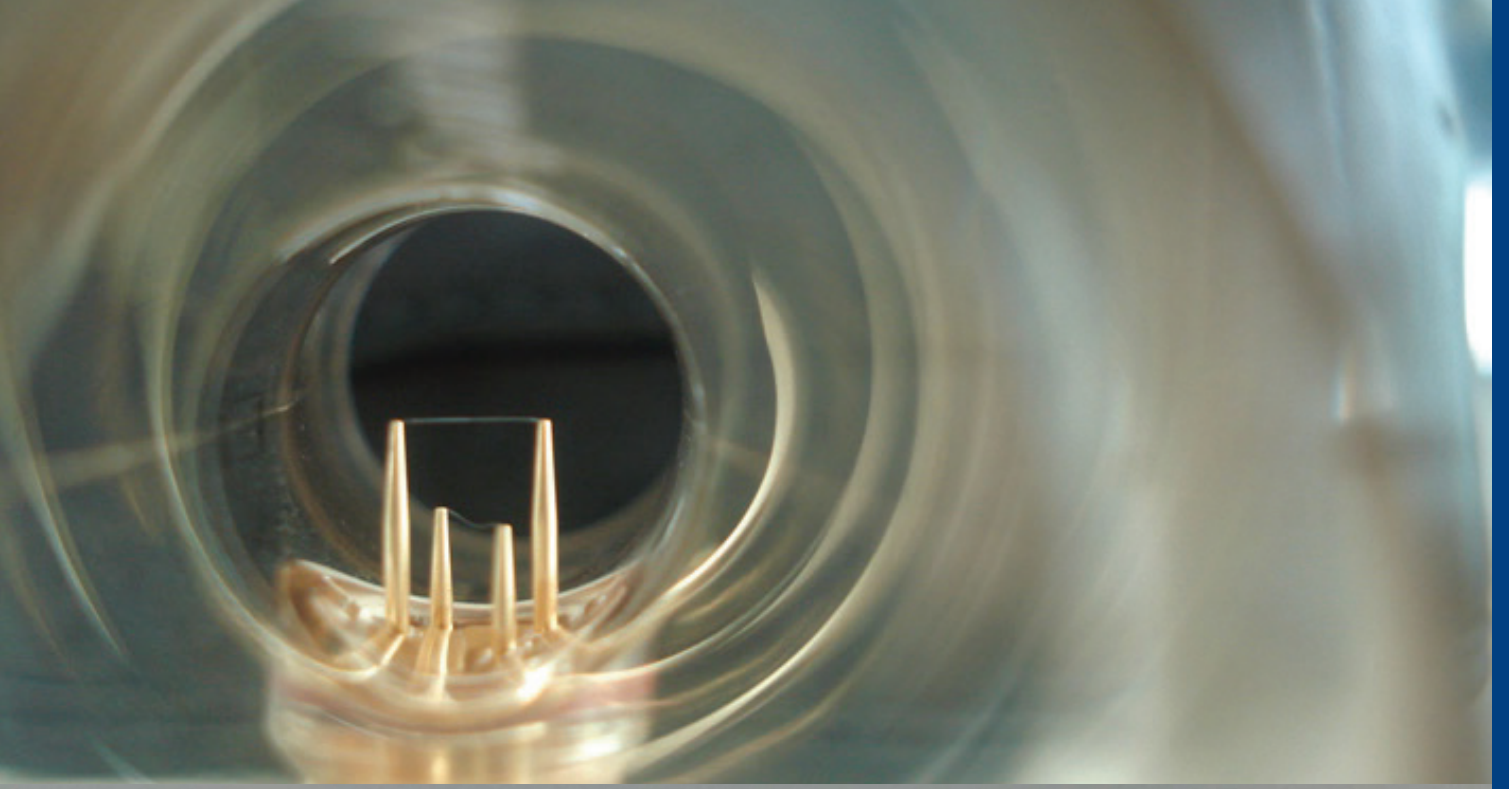

# SPO2 PROBLAR

**Yetişkin, Pediatrik, Neonatal hastalarda kullanım için konforlu ve hassas tek kullanımlık spo2 probları.**

Tek kullanımlık pulseoksimetreprobları, uzun süreli monitörizasyon veya hastalık bulaşma riskini yüksek olduğu durumlarda kullanım için idealdir.

Latex içermez ve endüstriyel standartlara uyarak biyouyumluluk sağlar.

Doğruluk %90-%100 arasında  $\pm$ -%1; %70-%89 arasında 4-2'dir. Faraday kafesi ekranlaması çevreden gelen manyetik etkileşimi azaltmakta ve ölçüm esnasında probun hassasiyetini artırmaktadır.

DISPOSABLE

## MICROFOAM TİP



## MEDAPLAST TİP

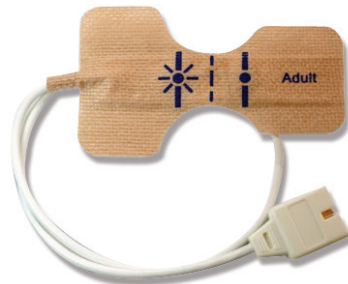

## VELCRO FASTEN TİP



## ÜRÜNE ÖZGÜ MARKA SEÇENEKLERİ

**DRAEGER, MINDRAY, NELLCOR, NELLCOR OXIMAX,  
GE HEALTHCARE, PETAŞ, NONIN, SCHILLER, NIHON KOHDEN,  
SPACELABS.**



www.bmtmedical.com

specialty for getting  
and transferring signals

### Neonatal / Adult Oxygen Sensor

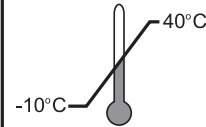
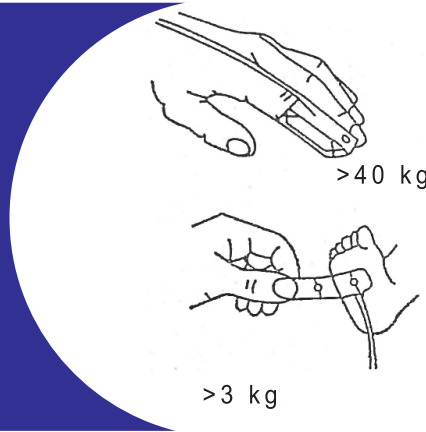

CE 0123

IPX1

Rx Only

Contains: 1 piece

- Compatible:
- BCI oximeters
  - CSI oximeters
  - Datascope patient
  - Datex patient monitor
  - Ohmeda oximeters
  - Dolphin oximeters
  - Nonin oximeters
  - Nellcor oximeters
  - Nihon Kohden patient monitor
  - Novametrix patient monitor
  - Palco oximeters

Importer:

**BMT MEDİKAL SİST. VE ÜRÜNL. SAN.VE DIŞ TİC.LTD.ŞTİ.**  
Küçükyalı - İstanbul / TÜRKİYE Tel: 0216 518 65 45 - 46  
Fax: 0216 518 65 47 e-mail : info@bmtmedical.com



LOT

REF

# IBP SETLER

DISPOSABLE URUNLER

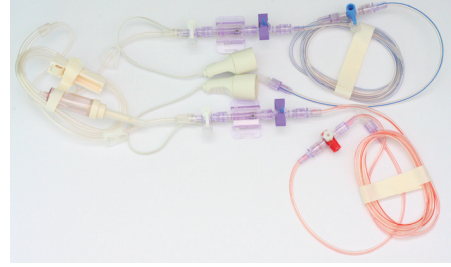
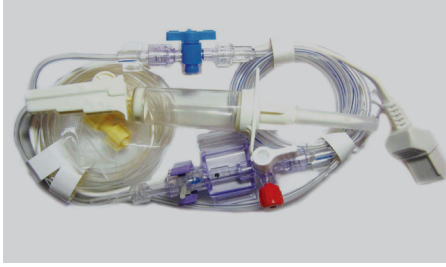

## HEMODİNAMİK BASINÇ TAKİP SETLERİ (ABBOTT, EDWARS, UTAH, BD)

### DISPOSABLE ENTERAL FEEDING SET



### Damla Ayar Seti

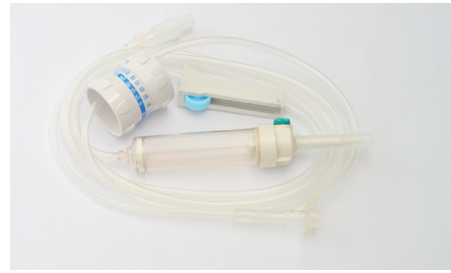

### İnfüzyon Setleri



# IBP KABLolar

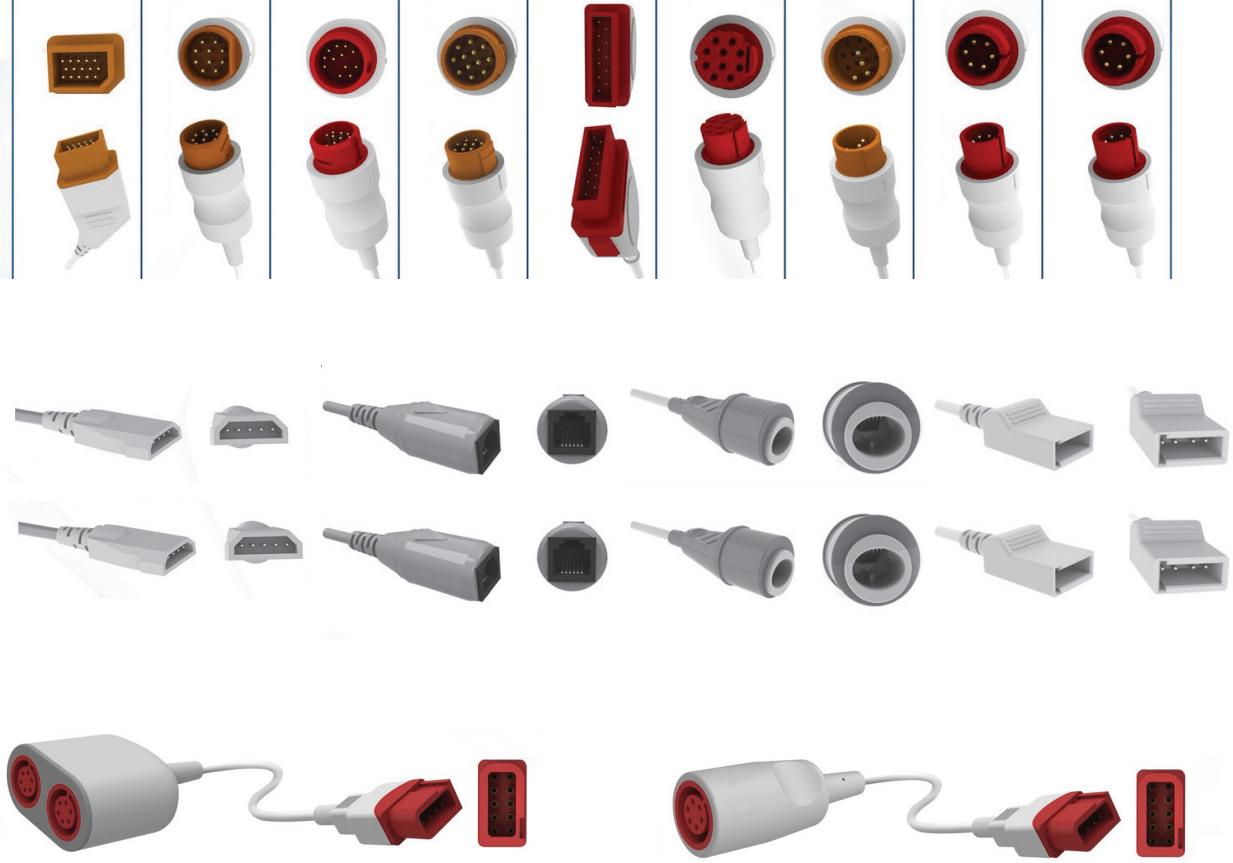

www.bmtmedikal.com.tr

## sağlıklı yaşam teknolojileri



# BİPOLAR FORCEPSLER

KOTER AKSESUARLARI

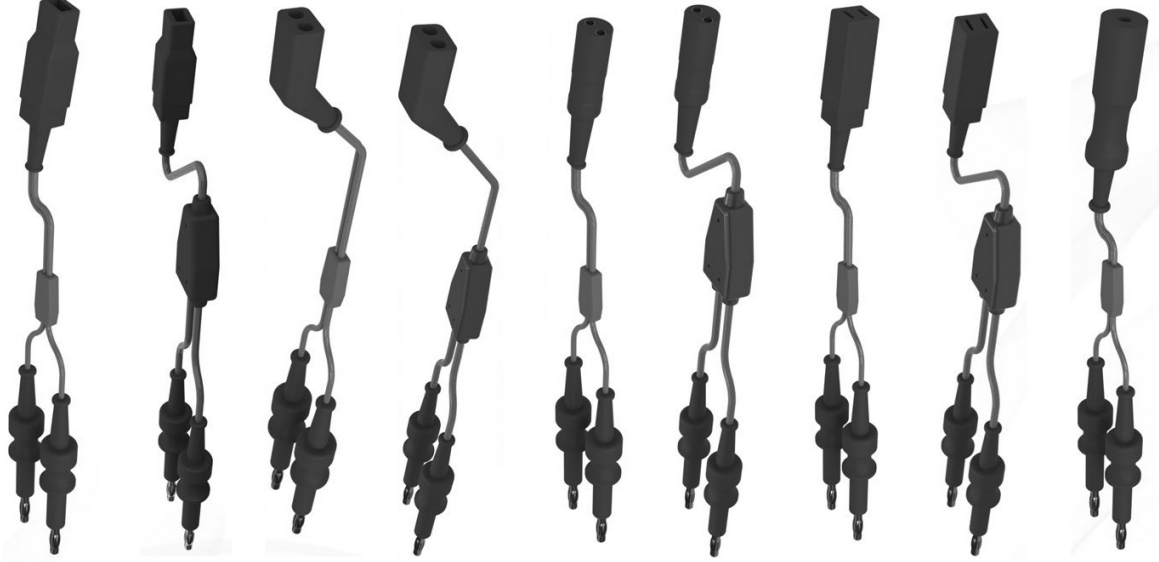



# güvenilir sađlık ekipmanları

## ISI PROBLARI



## KÜVÖZ ISI PROBLARI

DRAEGER, DAVID, ATOM, AIR SHIELDS,



## HASTABAŞI MÖNİTÖRÜ ISI PROBLARI

**DRAEGER, MINDRAY, NELLCOR, NELLCOR OXIMAX,  
GE HEALTCARE, PETAŞ, NONIN, SCHILLER, NIHON KOHDEN,  
SPACELABS, GUOTENG, COLIN, PHILIPS, GOLDWAY.**



# EKG KABLolar

EKG KABLolar



EKG KABLO 10 LEAD BANANA



EKG KABLO 10 LEAD BANANA



PHILIPS TRIM EKG KABLO 10 LEAD BANANA

www.bmtmedikal.com.tr

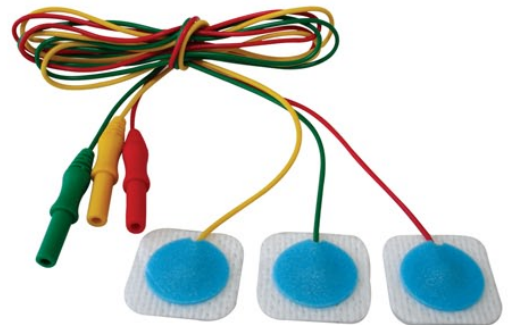

## HER MARKA VE MODEL EKG CİHAZI İÇİN KABLO SEÇENEKLERİ



EKG KABLO 10 LEAD



EKG KABLO 10 LEAD QUINTON



EKG KABLO 10 LEAD BANANA



EKG KABLO 10 LEAD



EKG KABLO 10 LEAD ÇİTÇİT



EKG KABLO 10 LEAD KISKAÇ



EKG KABLO 10 LEAD BANANA



EKG KABLO 10 LEAD BANANA

# EKG KABLOLAR

## HASTABAŞI MÖNİTÖRÜ EKG LEAD ÇEŞİTLERİ

**DRAEGER, MINDRAY, NELLCOR, GE HEALTHCARE, PETAŞ,  
NONIN, SCHILLER, NIHON KOHDEN, SPACELABS, GUOTENG,  
COLIN, PHILIPS, GOLDWAY.**

EKG LEAD ÇEŞİTLERİ

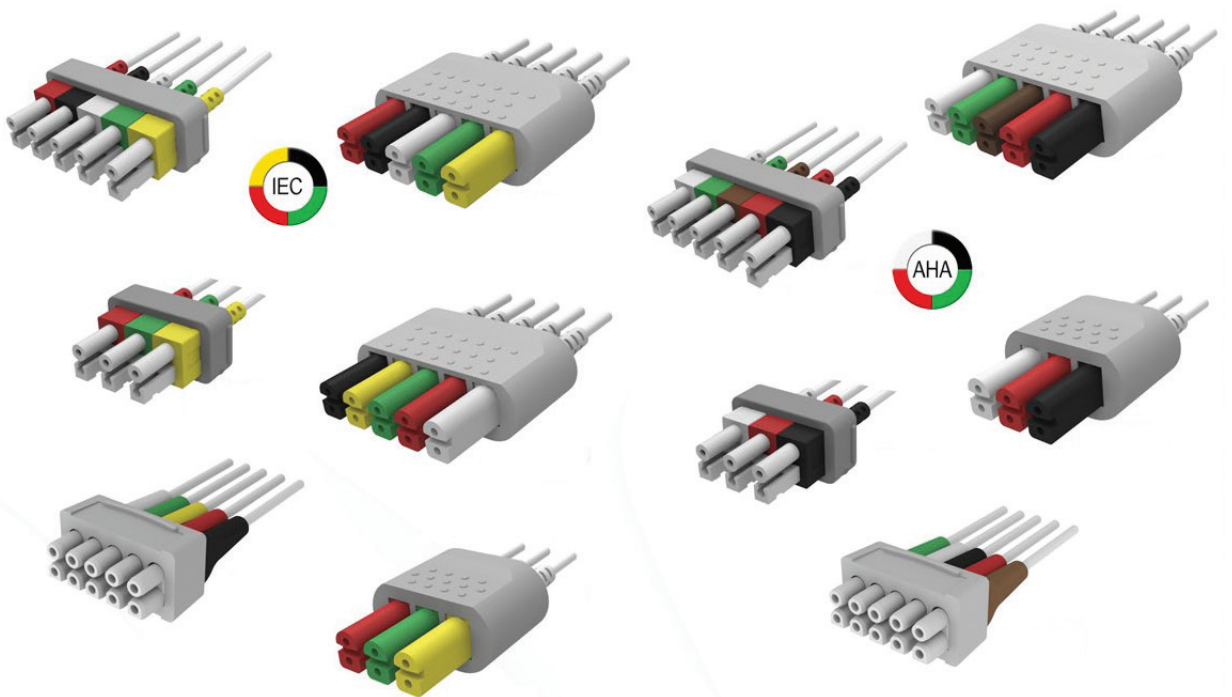

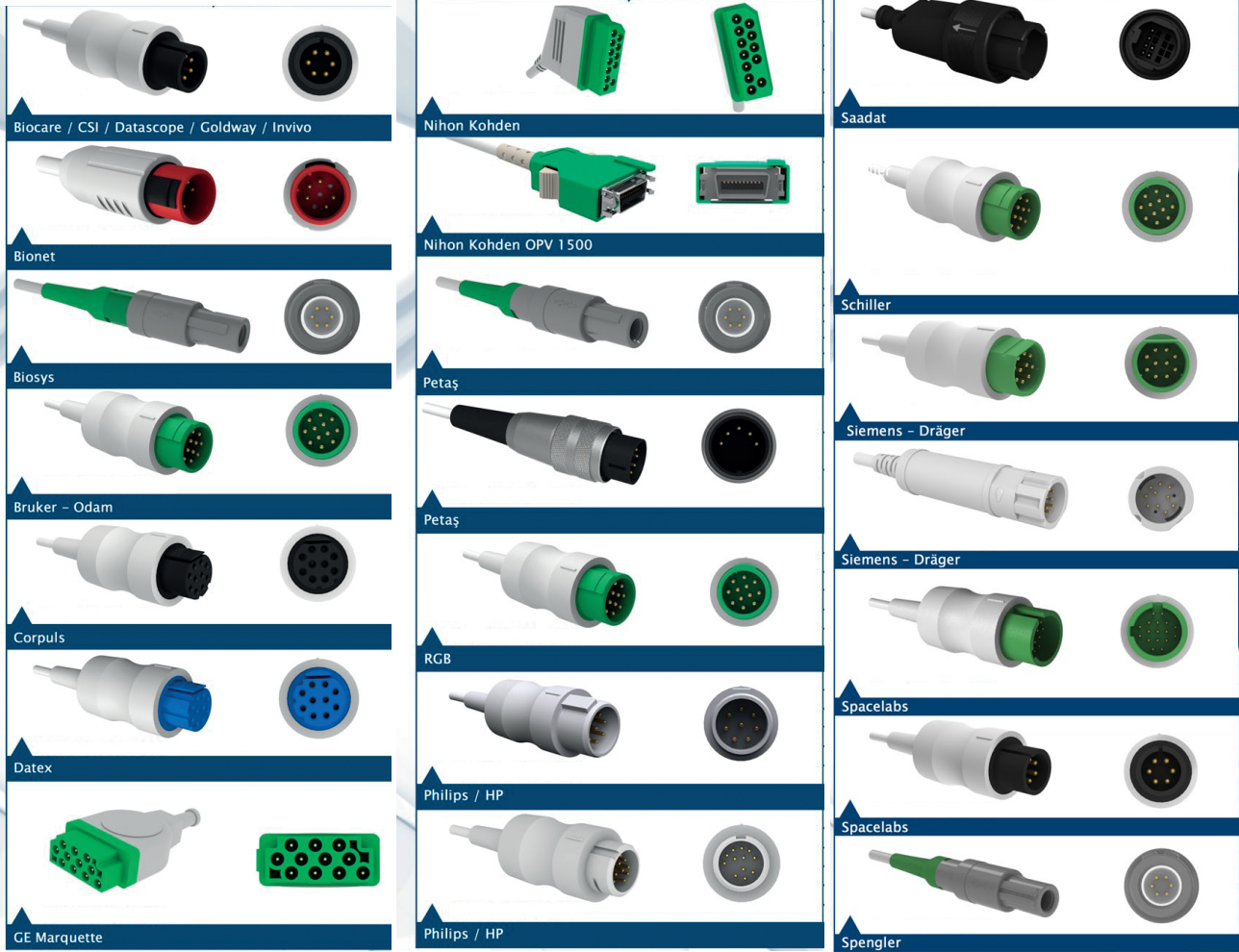

# en kapsamlı sağlık



# teknolojik ekipmanları

[www.bmtmedikal.com.tr](http://www.bmtmedikal.com.tr)



[www.bmtmedikal.com.tr](http://www.bmtmedikal.com.tr)

# SPO2 KABLolar

SPO2 KABLolar

www.bmtmedikal.com.tr

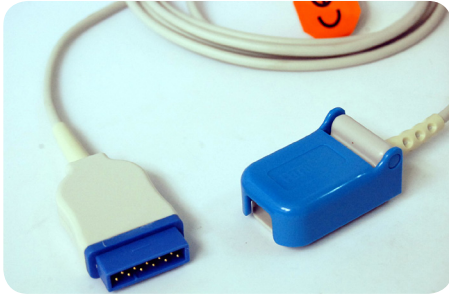

**NELLCOR**

DB9 dişi > DOC 10, 14 kutuplu mavi konektör, 2.4 m  
**NELLCOR Prob**  
 NELLCOR OXIMAX > NELLCOR



DB9 dişi > DB9 erkek, mavi konektör, 2.4 m  
**NELLCOR Prob**  
 NELLCOR OXIMAX > NELLCOR

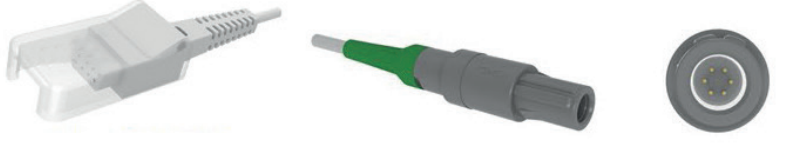

DB9 dişi > DB9 erkek, mavi konektör, 0.2 m  
**NELLCOR Prob**  
 NELLCOR OXIMAX > NELLCOR

**NEWTECH SOLARIS**

DB9 dişi > Redel 6 pim, 40° çentikli, yeşil kablo koruyuculu, 2.4 m  
**NEWTECH SOLARIS Prob**

**NIHON KOHDEN**

DB9 NK dişi > NK 15 pim, mavi konektör, 2.4 m  
**NIHON KOHDEN Prob**

**NIHON KOHDEN OXPAL**

DB9 dişi > 3M 20 pim mavi konektör, 2.4 m  
**NIHON KOHDEN Prob**

**NIHON KOHDEN**

DB9 NK dişi > NK 14 pim mavi menekşe konektör, 2.4 m  
**NELLCOR OXIMAX Prob**

**NONIN**

DB9 dişi > DB9 erkek siyah konektör, 2.4 m, **NONIN Prob**

**HER MARKA VE MODEL SPO2 KABLO SEÇENEKLERİ.**



www.bmtmedikal.com.tr



# SPO2 PROBLAR

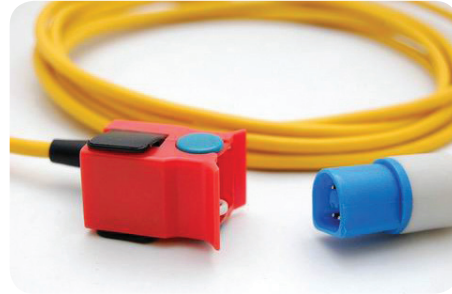
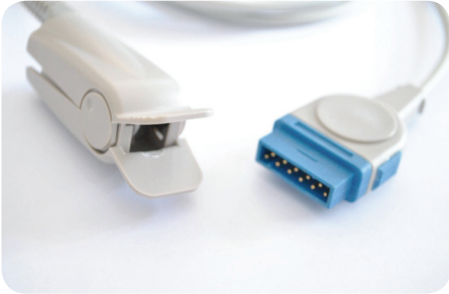
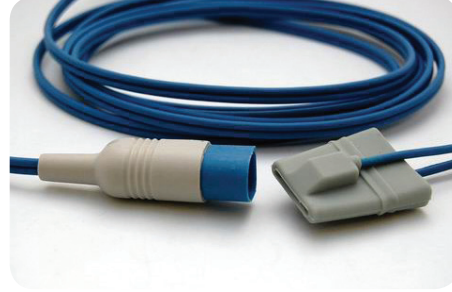

**RNS**  
 Çok Kullanımlık-Neonatal Dolamalı Yumuşak  
 Sensör  
 Kablo Uzunluğu: 0.9 m veya 3.0 m  
 Uygulama: Neonatal 1-4 kg  
 Uygulama Alanı: Neonatal / ayak



**RYS**  
 Çok Kullanımlık -Y Sensör  
 Kablo Uzunluğu: 0.9 m veya 3.0 m  
 Uygulama: Yetişkin > 40 kg; Pediatrik 10 - 40 kg;  
 Infant 3-15 kg; Neonatal 1-4 kg  
 Uygulama Alanı: Yetişkin ve Pediatrik işaret  
 parmağı veya diğer parmak; Infant/ ayak baş  
 parmağı; Neonatal / ayak

REUSABLE

www.bmtmedikal.com.tr

HER MARKA VE MODEL SPO2 PROB SEÇENEKLERİ

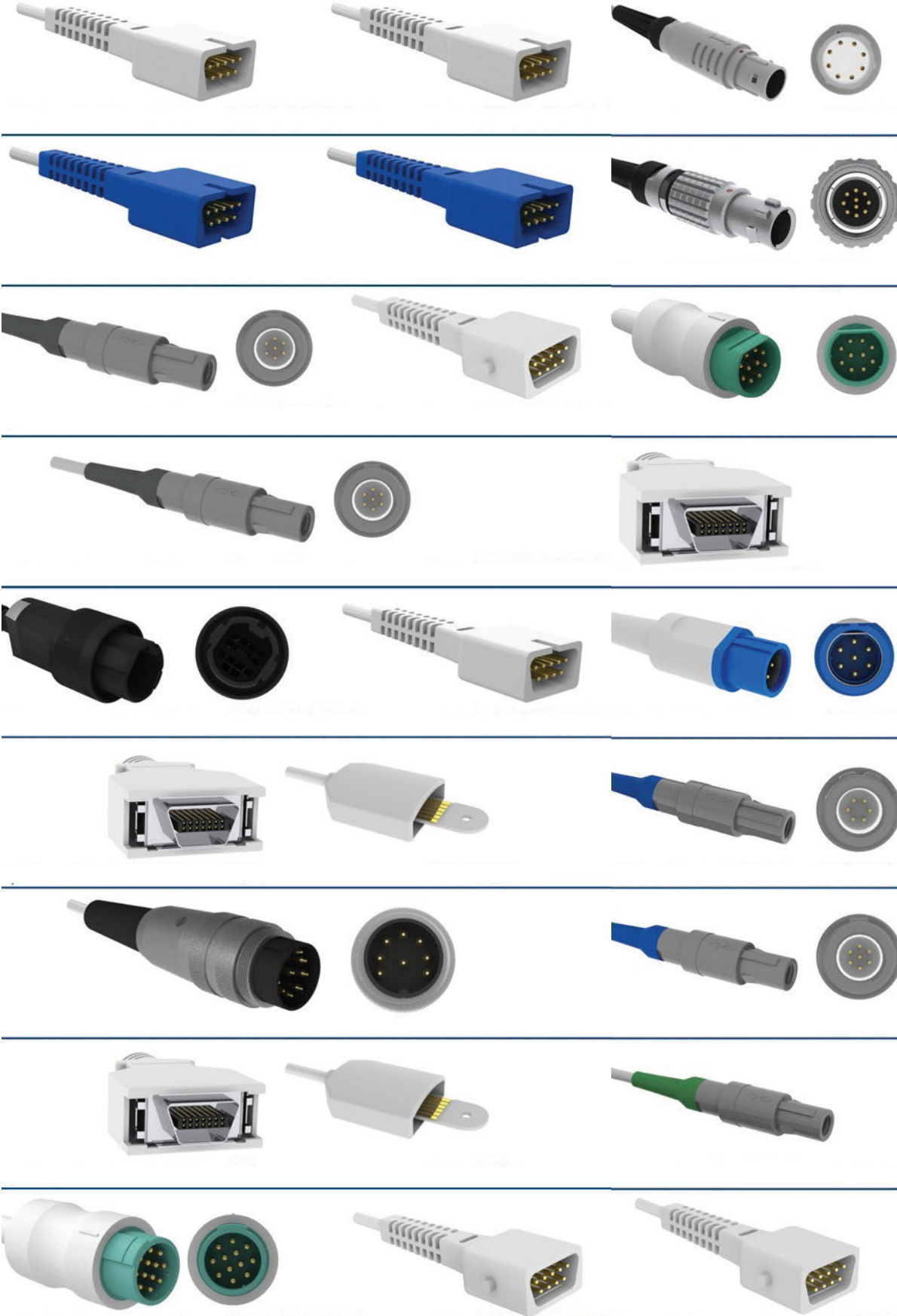

# TANSİYON MANŞONLARI

TANSİYON MANŞONLARI



<p>Single Tube Cuffs</p>	<p><b>BP12</b> CAS 740-750, Criticare 508, Datascope Accutor Plus &amp; Passport 2, Philips/ HP, Siemens, Spacelabs.</p>	<p><b>BP03</b> BCI, Colin, Datascope, Passport XG and Expert, Nihon Kohden, Lifescope 9&amp;12, Welch Allyn Vital Signs, Atlas</p>	<p><b>BP02</b> Welch Allyn Vital Signs, Atlas</p>	<p><b>BP18</b> Welch Allyn Protocol Propaq</p>
	<p>Double Tube Cuffs</p>	<p><b>BP0202</b> Critikon, Dinamap, Criticare 507, Invivo Research, MDE, Nihon Kohden Lifescope L, Spacelabs</p>	<p><b>BP1718</b> Datex Ohmeda</p>	<p><b>BP1818</b> GE Medical Eagle 4000, Tram 100/200/300</p>

# TANSİYON HORTUMLARI

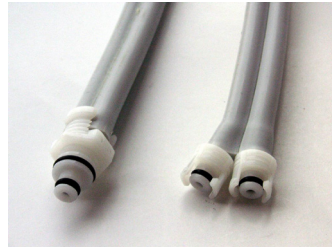

# NIBP KONNEKTÖRLER



# AKSESUARLAR

AKSESUARLAR



[www.bmtmedikal.com.tr](http://www.bmtmedikal.com.tr)





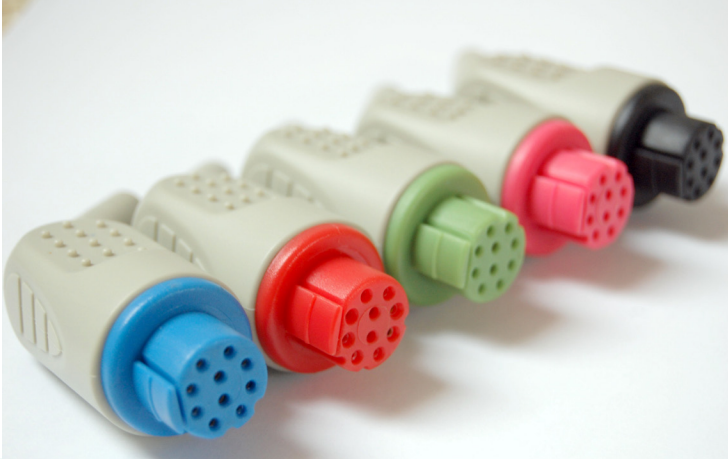
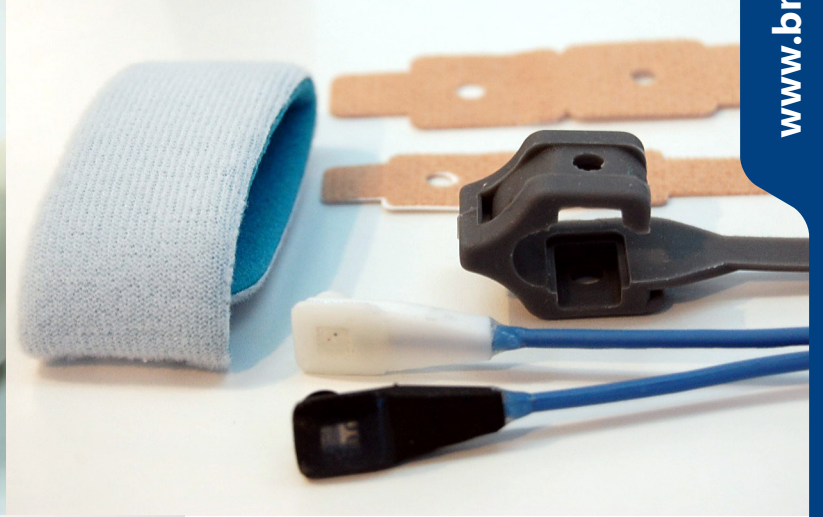



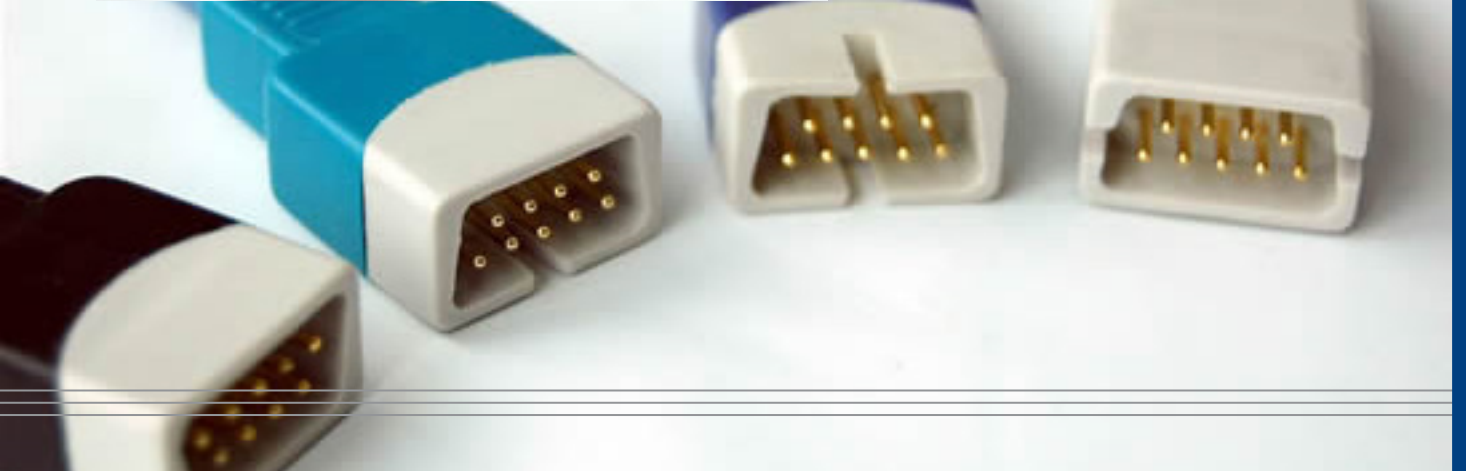

# KONNEKTÖR & SENSÖRLER

















**HER MARKA VE MODEL  
AKSESUAR YEDEK PARÇALARI  
MEVCUTTUR.**









Direct Connect Reusable SpO<sub>2</sub> Sensor

Compatible Brand	Compatible Models No.	INSTRUMENT CONNECTOR	OEM P/N	REF NO.	SENSOR TYPE
<b>DATASCOPE</b>	Datascop:Accutorr 3/4 SAT Accutorr Plus, Passport (Database Sp02) Compatible for 0020-00-071-01		0020-00-071-01	S0052B-L	Adult finger clip
				S0052D-L	Adult silicone soft
				S0052E-L	Infant silicone
				S0052F-L	Neonate wrap(undetachable)
				S0052I-L	Forehead SpO2 sensor Neonate wrap sensor(detachable)
<b>DATEX</b>	Datex:AS/3,CS/3,CH/S,CH/2S,CH-RS, CG/2S,Cardiicap I,Cardiicap II, Cardiicap 5, Capnomac Ultima, Light Monitor, M-Estpr, Oscar II, OSP-200, Satllite Trans, Satllite Trans Plus, System 5, ULTS00, original factory code :SAF-F4		OXY-F4-N	S0036B-L	Adult finger clip
				S0036C-L	Pediatric finger clip
				S0036D-L	Adult silicone soft
				S0036E-L	Infant silicone
				S0036F-L	Neonate wrap(undetachable)
			OXY-E4-N	S0036G-L	Adult ear clip sensor Veterinary SpO2 sensor
				S0036I-L	Forehead SpO2 sensor Neonate wrap sensor(detachable)
<b>OHMEDA</b>	Datex-Ohmeda:3740, 3710, 4700 OxiCap, 5250RGM, Biox 3760, Ohmeda 3700, 3770,3775, Rascal II), GE Medical Systems:7000 Series, Corometrics 511, TRAM A.R. , TRAM Modular x00SL Series), Mennen:Horizon XL800 (Ohmeda SpO2)		OXY-F4-H	S0014B-L	Adult finger clip
				S0014C-L	Pediatric finger clip
				S0014D-L	Adult silicone soft
				S0014E-L	Infant silicone
			OXY-W4-H	S0014F-L	Neonate wrap(undetachable)
				S0014I-L	Forehead SpO2 sensor Neonate wrap sensor(detachable)
<b>GE Ohmeda</b>	Sensor solutions for GE Ohmeda TruSat™ pulse oximeter:		OXY-F4-MC	S0127B-L	Adult finger clip
				S0127C-L	Pediatric finger clip
				S0127D-L	Adult silicone soft
				S0127F-L	Neonate wrap(undetachable)
			OXY-E4-MC	S0127G-L	Adult ear clip sensor Veterinary SpO2 sensor
	S0127I-L	Forehead SpO2 sensor Neonate wrap sensor(detachable)			
<b>DOLPHIN (OSI)</b>	Dolphin ONE Oximeters 2150, 2100 compatible for :2G00751. original factory code : 201 original factory code : 360 *digital PD output directly DS.		210	S0099B-L	Adult finger clip
				S0099D-L	Adult silicone soft
				S0099E-L	Infant silicone
			360	S0099F-L	Neonate wrap(undetachable)
				S0099I-L	Forehead SpO2 sensor Neonate wrap sensor(detachable)
<b>GE-Marquette (masimo module)</b>	Dash 3000/4000/5000 with Masimo option Solar 8000/8000M, i/9500 with Tram Module 451M/851M CardioLab®/Mac-Lab® with Tram Module 451M Corometrics® 259			S0025B-L	Adult finger clip
				S0025C-L	Pediatric finger clip
				S0025D-L	Adult silicone soft
				S0025P-L	Pediatric silicone
				S0025E-L	Infant silicone
				S0025F-L	Neonate wrap(undetachable)
				S0025G-L	Adult ear clip sensor Veterinary SpO2 sensor
				S0025I-L	Forehead SpO2 sensor Neonate wrap sensor(detachable)
<b>GE-Marquette (Nellcor module)</b>	Dash 2000/3000/4000 with Nellcor option,Dash 3000/4000/5000 with Ohmeda option, Solar 8000/8000M, i/9500 with Tram Module 451/451N/851/851N, CardioLab® /Mac-Lab®with Tram Module 451/451N Corometrics® 120/2120 series Eagle 1000/3000/4000 Responder 3000 with			S0002B-L	Adult finger clip
				S0002C-L	Pediatric finger clip
				S0002D-L	Adult silicone soft
				S0002E-L	Infant silicone
				S0002F-L	Neonate wrap(undetachable)
				S0002G-L	Adult ear clip sensor Veterinary SpO2 sensor
				S0002I-L	Forehead SpO2 sensor Neonate wrap sensor(detachable)
<b>GE-Medical (Oxi-tech)</b>	Dash 3000/4000/5000 with Nellcor OxiMax option Solar 8000/8000M, i9500 with Tram module 451N5/851N5			S0122B-L	Adult finger clip
				S0122C-L	Pediatric finger clip
				S0122D-L	Adult silicone soft
				S0122F-L	Neonate wrap(undetachable)
				S0122G-L	Adult ear clip sensor Veterinary SpO2 sensor
	S0122I-L	Forehead SpO2 sensor Neonate wrap sensor(detachable)			















Direct Connect Reusable SpO<sub>2</sub> Sensor

Compatible Brand	Compatible Models No.	INSTRUMENT CONNECTOR	OEM P/N	REF NO.	SENSOR TYPE
<b>GE Medical Datex-Ohmeda</b>	S/5, i4 Modular Monitors with E-series modules Corometrics® 259 with TruSignal Ohmeda Technology			S0128B-L	Adult finger clip
				S0128C-L	Pediatric finger clip
				S0128D-L	Adult silicone soft
				S0128F-L	Neonate wrap(undetachable)
				S0128G-L	Adult ear clip sensor Veterinary SpO <sub>2</sub> sensor
				S0128I-L	Forehead SpO <sub>2</sub> sensor Neonate wrap sensor(detachable)
<b>GOLDWAY</b>	4000F			S0038B-L	Adult finger clip
				S0038C-L	Pediatric finger clip
				S0038E-L	Infant silicone
				S0038G-L	Adult ear clip sensor Veterinary SpO <sub>2</sub> sensor
				S0038I-L	Forehead SpO <sub>2</sub> sensor Neonate wrap sensor(detachable)
				GOLDWAY:UT4000A, UT4000C  PACE TECH	
	S0007C-L	Pediatric finger clip			
	S0007D-L	Adult silicone soft			
	S0007F-L	Neonate wrap(undetachable)			
	S0007G-L	Adult ear clip sensor Veterinary SpO <sub>2</sub> sensor			
	S0007I-L	Forehead SpO <sub>2</sub> sensor Neonate wrap sensor(detachable)			
				S0061B-L	Adult finger clip
				S0061C-L	Pediatric finger clip
				S0061D-L	Adult silicone soft
				S0061E-L	Infant silicone
				S0061F-L	Neonate wrap(undetachable)
				S0061G-L	Adult ear clip sensor Veterinary SpO <sub>2</sub> sensor
	<b>Hellige</b>	Servomed 4 Generation SCP 844,851,852; SCS 804; SMK 151, 153,154,155-1,156,157, SMK181,182,SMV 104T,107,111,168;SMS316; SMC108;SMV104,Servomed N4, Servocard, Serie Cardioserv,Vicom SM,SMU 511,611,612,630 Serie SMK-200, SMK210,211,230.231.240,250, Pepita 203, R204,204R,205, Pepita 205R			S0006B-L
S0006C-L					Pediatric finger clip
S0006D-L					Adult silicone soft
S0006E-L					Infant silicone
S0006F-L					Neonate wrap(undetachable)
S0006I-L					Forehead SpO <sub>2</sub> sensor Neonate wrap sensor(detachable)
<b>INVIVO / MDE (Masimo module)</b>	M8			S0094B-L	 Adult finger clip
				S0094D-L	 Adult silicone soft
				S0094P-L	 Pediatric silicone
				S0094E-L	 Infant silicone
				S0094F-L	 Neonate wrap(undetachable)
				S0094G-L	 Adult ear clip sensor Veterinary SpO <sub>2</sub> sensor
				S0094I-L	 Forehead SpO <sub>2</sub> sensor Neonate wrap sensor
<b>INVIVO / MDE (Nellocr module)</b>	4500,4500Plus,Millenia,  Sat Scout			9383 S0083B-L	Adult finger clip
				S0083D-L	Adult silicone soft
<b>Kernel Medical</b>				S0057C-L	Pediatric finger clip
				S0057D-L	Adult silicone soft
				S0057E-L	Infant silicone
				S0057F-L	Neonate wrap(undetachable)
				S0057G-L	Adult ear clip sensor Veterinary SpO <sub>2</sub> sensor
S0057I-L	Forehead SpO <sub>2</sub> sensor Neonate wrap sensor(detachable)				









Direct Connect Reusable SpO<sub>2</sub> Sensor

Compatible Brand	Compatible Models No.	INSTRUMENT CONNECTOR	OEM P/N	REF NO.	SENSOR TYPE	
<b>Mennen medical</b>	Horizon2000			S0009B-L	Adult finger clip	
				S0009C-L	Pediatric finger clip	
				S0009D-L	Adult silicone soft	
				S0009E-L	Infant silicone	
				S0009F-L	Neonate wrap(undetachable)	
				S0009G-L	Adult ear clip sensor Veterinary SpO <sub>2</sub> sensor	
				S0009I-L	Forehead SpO <sub>2</sub> sensor Neonate wrap sensor(detachable)	
<b>MINDRAY</b>	Mindray: PM9000 *(BCI module)	074/467 		S0007B-L	Adult finger clip	
				S0007C-L	Pediatric finger clip	
				S0007D-L	Adult silicone soft	
				S0007F-L	Neonate wrap(undetachable)	
				S0007G-L	Adult ear clip sensor Veterinary SpO <sub>2</sub> sensor	
	S0007I-L	Forehead SpO <sub>2</sub> sensor Neonate wrap sensor(detachable)				
	Mindray: PM7000,6201,8000,9000 VS800(Mindray module), MEC1200 Kontron:7138,7840,7845 ChaoLiDe ,JinKeWei, QiLan BangJian:BM9000 Creative/:PC9000,UP6000  *Markets: China, CE, FDA PM600	378/200 		0010-20-42594 + 512D	S0040B-L	Adult finger clip
					S0040C-L	Pediatric finger clip
					S0040D-L	Adult silicone soft
					S0040E-L	Infant silicone
S0040F-L					Neonate wrap(undetachable)	
S0040I-L	Forehead SpO <sub>2</sub> sensor Neonate wrap sensor(detachable)					
S0040G-L	Adult ear clip sensor Veterinary SpO <sub>2</sub> sensor					
<b>MINDRAY (Nellcor module)</b>	8002、9201、PM7000(Since Jan. 2006) patient monitor of Nellcor module and 6pin plug (80° between 2bit)	387 	0010-20-42595(E)	S0129B-L	Adult finger clip	
				S0129C-L	Pediatric finger clip	
				S0129P-L	Pediatric silicone	
				S0129E-L	Infant silicone	
				S0129F-L	Neonate wrap(undetachable)	
				S0129G-L	Adult ear clip sensor Veterinary SpO <sub>2</sub> sensor	
				S0129I-L	Forehead SpO <sub>2</sub> sensor Neonate wrap sensor(detachable)	
<b>MINDRAY (masimo module)</b>	VS800 *(Masimo module)	387 	0010-20-42595	S0134B-L	Adult finger clip	
				S0134C-L	Pediatric finger clip	
				S0134D-L	Adult silicone soft	
				S0134E-L	Infant silicone	
				S0134F-L	Neonate wrap(undetachable)	
				S0134G-L	Adult ear clip sensor Veterinary SpO <sub>2</sub> sensor	
				S0134I-L	Forehead SpO <sub>2</sub> sensor Neonate wrap sensor(detachable)	
<b>MINDRAY (masimo module)</b>	PM9000,9100,9200,  PM-6201,7000,8000,M1K0,M2K0 (before 2006,Jan.)  *Radel 2bit-40° plug (general)  *(Masimo module)	241/569 	0010-30-42602	S0013B-L	Adult finger clip	
				S0013C-L	Pediatric finger clip	
				S0013D-L	Adult silicone soft	
				S0013E-L	Infant silicone	
				S0013F-L	Neonate wrap(undetachable)	
				S0013G-L	Adult ear clip sensor Veterinary SpO <sub>2</sub> sensor	
				S0013I-L	Forehead SpO <sub>2</sub> sensor Neonate wrap sensor(detachable)	
	PM9000express(.Masimo). PM8002,9201, (PM-6201,7000,8000,M1K0,M2K0 since 2006), T8 Marketing:SFDA,CE,FDA OEM No	241/569 		0010-30-42625	S0116B-L	Adult finger clip
					S0116C-L	Pediatric finger clip
					S0116D-L	Adult silicone soft
					S0116E-L	Infant silicone
					S0116F-L	Neonate wrap(undetachable)
					S0116I-L	Forehead SpO <sub>2</sub> sensor Neonate wrap sensor(detachable)









Direct Connect Reusable SpO<sub>2</sub> Sensor

Compatible Brand	Compatible Models No.	INSTRUMENT CONNECTOR	OEM P/N	REF NO.	SENSOR TYPE				
MINDRAY	Mindray/:509B,500A,PM9000	429/430 		S0053B-L	Adult finger clip				
	Goldway/:Industrial, UT4000			S0053C-L	Pediatric finger clip				
	*Markets: China			S0053I-L	Forehead SpO <sub>2</sub> sensor Neonate wrap sensor(detachable)				
	MINDRAY	MEC-509,509+,503,507	451/452 		S0011B-L	Adult finger clip			
					S0011C-L	Pediatric finger clip			
					S0011D-L	Adult silicone soft			
					S0011E-L	Infant silicone			
					S0011F-L	Neonate wrap(undetachable)			
					S0011G-L	Adult ear clip sensor Veterinary SpO <sub>2</sub> sensor			
					S0011I-L	Forehead SpO <sub>2</sub> sensor Neonate wrap sensor(detachable)			
				MINDRAY (masimo module)	Mindray/: PM5000,PM6000. *(BCI module)	424/425 		S0045B-L	Adult finger clip
								S0045C-L	Pediatric finger clip
		S0045D-L	Adult silicone soft						
		S0045E-L	Infant silicone						
		S0045F-L	Neonate wrap(undetachable)						
	S0045G-L	Adult ear clip sensor Veterinary SpO <sub>2</sub> sensor							
MINDRAY (masimo module)	Mindray/: PM6000. *Markets: China, CE, FDA *(masimo module)	412/425 		S0012B-L	Adult finger clip				
				S0012C-L	Pediatric finger clip				
				S0012E-L	Infant silicone				
				S0012F-L	Neonate wrap(undetachable)				
				S0012G-L	Adult ear clip sensor Veterinary SpO <sub>2</sub> sensor				
				S0012I-L	Forehead SpO <sub>2</sub> sensor Neonate wrap sensor(detachable)				
NELLCOR (OXI-TECH)	*OXI TECH  N550, N595, N560	393/501 	DOC10 +DS100A	S0117B-L	 Adult finger clip				
				S0117C-L	 Pediatric finger clip				
				S0117D-L	 Adult silicone soft				
				S0117P-L	 Pediatric silicone				
				S0117E-L	 Infant silicone				
				S0117F-L	 Neonate wrap(undetachable)				
				S0117G-L	 Adult ear clip sensor Veterinary SpO <sub>2</sub> sensor				
				S0117I-L	 Forehead SpO <sub>2</sub> sensor Neonate wrap sensor				
			NELLCOR, Charmcare			EC8+DS100A	S0010B-L	Adult finger clip	
	S0010C-L	Pediatric finger clip							
	S0010D-L	Adult silicone soft							
	S0010E-L	Infant silicone							
	S0010F-L	Neonate wrap(undetachable)							
	S0010G-L	Adult ear clip sensor Veterinary SpO <sub>2</sub> sensor							
	S0010I-L	Forehead SpO <sub>2</sub> sensor Neonate wrap sensor(detachable)							
	370/048 								
<p><i>Artema/Diascope/Datascope/Accutorr Plus/Expert/Passport/Dräger; Cicero/Narkomed/Vitalert 1000 GEMS:Corometrics 118,120,129,188,510,556;GEMS:Critikon 9710,9720 Plus,Compact,Dinamap Select,MPS,Oxyshuttle,Pro 300/400 (non-OxiMax®);GEMS:Eagle Series,Dash Se</i></p> <p><i>Philips:78352C,78354C,78834C,M1020A,M1025B,M1205A,M1350B,M1722A/B,M1732A/B,M2475B,M2601A,M3000A,M3500B,M4735A,CMS Merlin Systems V24.V26.Viridia A1.Viridia A3:Siemens:SC6000,SC7000,SC8000,SC9000XL,Sirecust 630 Sirecust 700,Sirem SpO2 Module: SpaceLabs:</i></p>									









Direct Connect Reusable SpO<sub>2</sub> Sensor

Compatible Brand	Compatible Models No.	INSTRUMENT CONNECTOR	OEM P/N	REF NO.	SENSOR TYPE	
<b>NELLCOR, Charmcare</b>	Datascope: Accutorr Plus (Nellcor) Nellcor: NPB-290/5, N-390, , N-395, N-3000, N-6000, NPB-290/5, N-390, N-395, N-3000, N-6000, Nihon Kohden: BSM-4104A, BSM-4114A, Colin BP88/306		SCP10+ DS100A	S0001B-L	Adult finger clip	
				S0001C-L	Pediatric finger clip	
				S0001D-L	Adult silicone soft	
				S0001E-L	Infant silicone	
* <b>NELLCOR (OXI TECH)</b>	All Nellcor & Nellcor equipped OEM monitors		DEC8+ DS100A	S0026B-L	Adult finger clip	
				S0026C-L	Pediatric finger clip	
				S0026D-L	Adult silicone soft	
				S0026E-L	Infant silicone	
				S0026F-L	Neonate wrap(undetachable)	
				S0026G-L	Adult ear clip sensor Veterinary SpO2 sensor	
<b>NIHON KOHDEN</b>	Nihon Kohden: AL-800PA Module BSM-1101 LifeScope EC , BSM-2101/2 LifeScope L , BSM-3101 LifeScope LC , BSM-7100/7200 LifeScope 8 , BSM-8200/1 LifeScope 12 , SM-8800 LifeScope14, OLV-1100A		TL-101S	S0069B-L	Adult finger clip	
				S0069D-L	Adult silicone soft	
				S0069E-L	Infant silicone	
				S0069G-L	Adult ear clip sensor Veterinary SpO2 sensor	
				S0069I-L	Forehead SpO2 sensor Neonate wrap sensor(detachable)	
<b>NIHON KOHDEN</b>	Bedside Monitor: BSM-4101,4103 4111,4113 Life scope P BSM-5105,5135 Life scope A BSM-2351,2353 Life scope L BSM-2301,2303 Life scope I BSM-73		TL-201T	S0005B-L	Adult finger clip	
				S0005C-L	Pediatric finger clip	
				S0005D-L	Adult silicone soft	
				S0005P-L	Pediatric silicone	
				S0005F-L	Neonate wrap(undetachable)	
				S0005I-L	Forehead SpO2 sensor Neonate wrap sensor(detachable)	
<b>NONIN</b>	8600 series, 8500,8700,8800, 96,009,700			S0109B-L	Adult finger clip	
				S0109D-L	Adult silicone soft	
				S0109E-L	Infant silicone	
				S0109F-L	Neonate wrap(undetachable)	
				S0109G-L	Adult ear clip sensor Veterinary SpO2 sensor	
				S0109I-L	Forehead SpO2 sensor Neonate wrap sensor(detachable)	
	NONIN: 8500,8600,8700,8800 NONIN: 2500			8000AA	S0080B-L	Adult finger clip
					S0080C-L	Pediatric finger clip
					S0080D-L	Adult silicone soft
					S0080E-L	Infant silicone
					S0080F-L	Neonate wrap(undetachable)
					S0080G-L	Adult ear clip sensor Veterinary SpO2 sensor
					S0080I-L	Forehead SpO2 sensor Neonate wrap sensor(detachable)
					8604,8604D	
S0106C-L	Pediatric finger clip					
S0106D-L	Adult silicone soft					
S0106E-L	Infant silicone					
S0106F-L	Neonate wrap(undetachable)					
S0106G-L	Adult ear clip / Veterinary sensor					
<b>NOVAMETRIX</b>	Novamatrix: 505,510,511,515B/C,520 7000, 7100, Oxypleth ; original match : 8776-00 Spacelabs: 90351-D/G ,90465, 90466, 90467, 90489, 90651-07/08 , original match : 8776-00		8776-00	S0062B-L	Adult finger clip	
				S0062C-L	Pediatric finger clip	
				S0062D-L	Adult silicone soft	
				S0062E-L	Infant silicone	
				S0062F-L	Neonate wrap(undetachable)	
				S0062I-L	Forehead SpO2 sensor Neonate wrap sensor(detachable)	
<b>PACE TECH Generra</b>	Generra: 710, 200, 300, 400, 810, 530  PACE TECH: Modell520 . All w/ black face  (except Vitalmax 800w/Nellcor® SpO2)		4510+3044	S0082B-L	Adult finger clip	
				S0082C-L	Pediatric finger clip	
				S0082D-L	Adult silicone soft	
				S0082E-L	Infant silicone	
				S0082F-L	Neonate wrap(undetachable)	
				S0082G-L	Adult ear clip sensor Veterinary SpO2 sensor	
			4510+3044	S0082I-L	Forehead SpO2 sensor Neonate wrap sensor(detachable)	





















### Direct Connect Reusable SpO<sub>2</sub> Sensor

Compatible Brand	Compatible Models No.	INSTRUMENT CONNECTOR	OEM P/N	REF NO.	SENSOR TYPE
<b>PACE TECH</b> Generra	Generra			S0091B-L	Adult finger clip
				S0091C-L	Pediatric finger clip
				S0091D-L	Adult silicone soft
				S0091E-L	Infant silicone
				S0091F-L	Neonate wrap(undetachable)
				S0091G-L	Adult ear clip sensor Veterinary SpO <sub>2</sub> sensor
				S0091I-L	Forehead SpO <sub>2</sub> sensor Neonate wrap sensor(detachable)
<b>PALCO</b>	Palco: ALL			S0079B-L	Adult finger clip
				S0079D-L	Adult silicone soft
				S0079P-L	Pediatric silicone
<b>PRIMEDIC</b>			S0139B-L	Adult finger clip	
			S0139C-L	Pediatric finger clip	
			S0139D-L	Adult silicone soft	
			S0139E-L	Infant silicone	
			S0139F-L	Neonate wrap(undetachable)	
			S0139G-L	Adult ear clip sensor Veterinary SpO <sub>2</sub> sensor	
			S0139I-L	Forehead SpO <sub>2</sub> sensor Neonate wrap sensor(detachable)	
			S0140B-L	Adult finger clip	
			S0140C-L	Pediatric finger clip	
			S0140D-L	Adult silicone soft	
			S0140E-L	Infant silicone	
			S0140F-L	Neonate wrap(undetachable)	
			S0140G-L	Adult ear clip sensor Veterinary SpO <sub>2</sub> sensor	
			S0140I-L	Forehead SpO <sub>2</sub> sensor Neonate wrap sensor(detachable)	
<b>PHILIPS</b>	Philips: 78352A/C,78354A/C, 78834C,M1020A,M1025A/B, M1205A,M1350B,M1722A/B, M1723A/B,M2475B,V24E,		M1190A	S0003B-L	Adult finger clip
				S0003C-L	Pediatric finger clip
			M1190A	S0003D-L	Adult silicone soft
				S0003E-L	Pediatric silicone
				S0003F-L	Neonate wrap(undetachable)
				S0003I-L	Forehead SpO <sub>2</sub> sensor Neonate wrap sensor(detachable)
	M3,M4,MP20,MP30,MP40,MP50, MP70,MP80,VM4,VM6,VM8		M1191A	S0015B-L	Adult finger clip
			M1192A	S0015C-L	Pediatric finger clip
			M1191A	S0015D-L	Adult silicone soft
			M1192A	S0015E-L	Infant silicone
			M1193A	S0015F-L	Neonate wrap(undetachable)
			M1194A	S0015G-L	Adult ear clip sensor Veterinary SpO <sub>2</sub> sensor
				S0015I-L	Forehead SpO <sub>2</sub> sensor Neonate wrap sensor(detachable)
<b>S &amp; W ARTEMA</b>	S&W Artema Patient monitor  Compatible Original SL033057+DS100A		SL033057 +DS100A	S0023B-L	Adult finger clip
				S0023C-L	Pediatric finger clip
				S0023D-L	Adult silicone soft
				S0023E-L	Infant silicone
				S0023F-L	Neonate wrap(undetachable)
				S0023G-L	Adult ear clip sensor Veterinary SpO <sub>2</sub> sensor
				S0023I-L	Forehead SpO <sub>2</sub> sensor Neonate wrap sensor(detachable)
<b>S&amp;W Athena and Diascope</b>	S&W Athena and Diascope, 8000			S0156B-L	Adult finger clip
				S0156C-L	Pediatric finger clip
				S0156D-L	Adult silicone soft
				S0156E-L	Pediatric silicone
				S0156F-L	Neonate wrap(undetachable)
				S0156G-L	Adult ear clip sensor Veterinary SpO <sub>2</sub> sensor
				S0156I-L	Forehead SpO <sub>2</sub> sensor Neonate wrap sensor(detachable)
<b>SCHILLER (Nellocr module)</b>	Schiller Argus TM-7			S0028B-L	Adult finger clip
				S0028C-L	Pediatric finger clip
				S0028D-L	Adult silicone soft
				S0028E-L	Infant silicone
				S0028F-L	Neonate wrap(undetachable)
				S0028G-L	Ear clip&Veterinary SpO <sub>2</sub> sensor
				S0028I-L	Forehead SpO <sub>2</sub> sensor Neonate wrap sensor(detachable)







## Direct Connect Reusable SpO<sub>2</sub> Sensor

Compatible Brand	Compatible Models No.	INSTRUMENT CONNECTOR	OEM P/N	REF NO.	SENSOR TYPE
<b>SCHILLER (masimo module)</b>	Argus Pro, Argus LCM			S0118B-L	Adult finger clip
				S0118C-L	Pediatric finger clip
				S0118E-L	Infant silicone
				S0118I-L	Forehead SpO <sub>2</sub> sensor Neonate wrap sensor(detachable)
<b>SIEMENS</b>	Siemens Medical:Sirecust 700 Sirecust 630 Sirem SpO <sub>2</sub> Module			S0078B-L	Adult finger clip
				S0078C-L	Pediatric finger clip
				S0078D-L	Adult silicone soft
				S0078E-L	Infant silicone
				S0078F-L	Neonate wrap(undetachable)
				S0078G-L	Ear clip&Veterinary SpO <sub>2</sub> sensor
				S0078I-L	Forehead SpO <sub>2</sub> sensor Neonate wrap sensor(detachable)
<b>SIEMENS, Drager</b>	Siemens/Darger:SC6002XL,7000, SC8000,SC9000XL			S0072B-L	Adult finger clip
				S0072D-L	Adult silicone soft
				S0072P-L	Pediatric silicone
				S0072E-L	Infant silicone
				S0072F-L	Neonate wrap(undetachable)
				S0072G-L	Adult ear clip sensor Veterinary SpO <sub>2</sub> sensor
				S0072I-L	Forehead SpO <sub>2</sub> sensor Neonate wrap sensor(detachable)
	Drager medical: Vitalert 1000, Cicero			S0119B-L	Adult finger clip
				S0119C-L	Pediatric finger clip
				S0119D-L	Adult silicone soft
				S0119E-L	Infant silicone
				S0119F-L	Neonate wrap(undetachable)
				S0119G-L	Adult ear clip sensor Veterinary SpO <sub>2</sub> sensor
<b>SIEMENS</b>				S0145B-L	Adult finger clip
				S0145C-L	Pediatric finger clip
				S0145D-L	Adult silicone soft
				S0145E-L	Infant silicone
				S0145F-L	Neonate wrap(undetachable)
				S0145G-L	Adult ear clip sensor Veterinary SpO <sub>2</sub> sensor
				S0145I-L	Forehead SpO <sub>2</sub> sensor Neonate wrap sensor(detachable)
<b>SIMED(Baxter)</b>	Baxter:ASAT SiMED:S-50 SiMED:S-100 SiMED:S-100e			S0120B-L	Adult finger clip
				S0120C-L	Pediatric finger clip
				S0120D-L	Adult silicone soft
				S0120E-L	Infant silicone
				S0120F-L	Neonate wrap(undetachable)
				S0120G-L	Adult ear clip sensor Veterinary SpO <sub>2</sub> sensor
				S0120I-L	Forehead SpO <sub>2</sub> sensor Neonate wrap sensor(detachable)
<b>SPACELABS</b>	Spacelabs Medical:90351-0/6; 90465; 0466; 90489; 90651A-08; 90651-A; IM77,90308. PC Scout			015-0130-00 S0035B-L	Adult finger clip
				+ DS-100A S0035C-L	Pediatric finger clip
				S0035D-L	Adult silicone soft
				S0035E-L	Infant silicone
				S0035F-L	Neonate wrap(undetachable)
				S0035G-L	Adult ear clip sensor Veterinary SpO <sub>2</sub> sensor
				S0035I-L	Forehead SpO <sub>2</sub> sensor Neonate wrap sensor(detachable)
				Spacelabs Medical: 1050,1600,1700,90369,90469,90496 Ultraview	
	S0004D-L	Adult silicone soft			
	S0004E-L	Infant silicone			
	S0004F-L	Neonate wrap(undetachable)			
	S0004G-L	Adult ear clip sensor Veterinary SpO <sub>2</sub> sensor			

Reusable SpO<sub>2</sub> Sensor (need ext-cable)

Compatible Brand	Compatible Models No.	INSTRUMENT CONNECTOR	OEM P/N	REF NO.	SENSOR TYPE
<b>BCI</b> (Biochem International)	<b>BCI(Biochem International):</b> 3401,3304,3303,3302,3301,3300;  <b>Spacelabs Burdick:</b> PRO2;  <b>Dräger:</b> Dräger Oxipac 2000  <b>Choice Electronic:</b> MD300M	  	3044	S0076B-S	 Adult finger clip
			3178	S0076C-S	 Pediatric finger clip
			3044	S0076D-S	 Adult silicone soft
				S0076P-S	 Pediatric silicone
			3178	S0076E-S	 Infant silicone
				S0076F-S	 Neonate wrap (undetachable)
				S0076G-S	 Adult ear clip sensor Veterinary SpO <sub>2</sub> sensor
				S0076I-S	 Forehead SpO <sub>2</sub> sensor Neonate wrap sensor
<b>BIONET KOREA</b>	BM3	  		S0084B-S	Adult finger clip
				S0084D-S	Adult silicone soft
				S0084E-S	Infant silicone
				S0084F-S	Neonate wrap (undetachable)
				S0084G-S	Adult ear clip sensor Veterinary SpO <sub>2</sub> sensor
				S0084I-S	Forehead SpO <sub>2</sub> sensor Neonate wrap sensor(detachable)
<b>CSI</b> Criticare Systems International	Alaris (IVAC):VitalCheck 4400 CSI(Criticare Systems International) 503DX,503Spot,504DX,506,506DX 507ELC2 ScholarIII,8100Poet Plus, Poet (602-3A) (Sensor + Cable), Scholar (Sensor + Cable)	  	511SD	S0044B-S	Adult finger clip
				S0044C-S	Pediatric finger clip
				S0044D-S	Adult silicone soft
				S0044E-S	Infant silicone
				S0044F-S	Neonate wrap (undetachable)
				S0044G-S	Adult ear clip / Veterinary sensor
<b>DATASCOPE</b>	Datascop:Accutorr 3/4 SAT Accutorr Plus, Passport (Database SpO2) Compatible for 0020-00-071-01	  		S0052B-S	Adult finger clip
				S0052D-S	Adult silicone soft
				S0052E-S	Infant silicone
				S0052F-S	Neonate wrap (undetachable)
				S0052G-S	Adult ear clip / Veterinary sensor
				S0052I-S	Forehead SpO <sub>2</sub> sensor Neonate wrap sensor(detachable)
<b>DATEX</b>	Datex:AS/3,CS/3,CH/S,CH/2S,CH-RS, CG/2S,Cardiocap I,Cardiocap II, Cardiocap 5, Capnomac Ultima, Light Monitor, M-Estrp, Oscar II, OSP-200, Satlite Trans, Satlite Trans Plus, System 5, ULTS00,  original factory code :SAF-F4	  	SAF-F	S0036B-S	Adult finger clip
				S0036C-S	Pediatric finger clip
				S0036D-S	Adult silicone soft
				S0036E-S	Infant silicone
				S0036F-S	Neonate wrap (undetachable)
				S0036G-S	Adult ear clip / Veterinary sensor
<b>OHMEDA</b> (Adaptor required: S0014BC-L)	<b>Datex-Ohmeda:</b> 3740, 3710, 4700 OxiCap, 5250RGM, Biox 3760, Ohmeda 3700, 3770,3775, Rascal II), <b>GE Medical Systems:</b> 7000 Series, Corometrics 511, TRAM A.R. ,  TRAM Modular x00SL Series),  Mennen:Horizon XL800 (Ohmeda SpO2)	  		S0014B-S	Adult finger clip
				S0014C-S	Pediatric finger clip
				S0014D-S	Adult silicone soft
				S0014E-S	Infant silicone
				S0014F-S	Neonate wrap (undetachable)
				S0014G-S	Adult ear clip sensor Veterinary SpO <sub>2</sub> sensor
<b>OHMEDA</b>	<b>Datex-Ohmeda:</b> 3740, 3710, only use for Ohmeda oximeter EMITTER: 660/940-3		OXY-F-UN	S0123B-S	Adult finger clip
				S0123C-S	Pediatric finger clip
				S0123D-S	Adult silicone soft
				S0123E-S	Infant silicone
			OXY-W-UN	S0123F-S	Neonate wrap (undetachable)
			OXY-E-UN	S0123G-S	Adult ear clip / Veterinary sensor
	S0123I-S	Forehead SpO <sub>2</sub> sensor Neonate wrap sensor(detachable)			



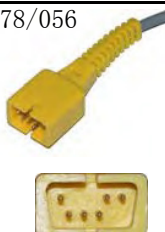
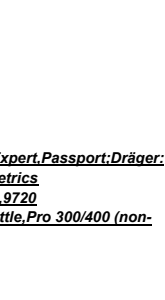
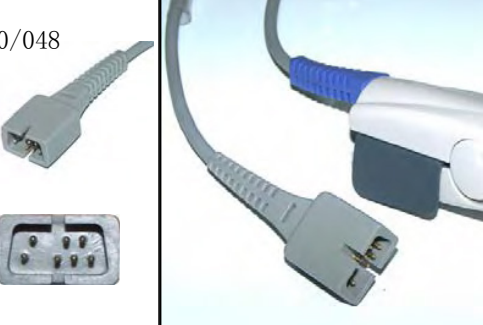





























### Reusable SpO<sub>2</sub> Sensor (need ext-cable)

Compatible Brand	Compatible Models No.	INSTRUMENT CONNECTOR	OEM P/N	REF NO.	SENSOR TYPE			
<b>DOLPHIN (OSI)</b>	Dolphin ONE Oximeters 2150, 2100 compatible for :2G00751.  original factory code : 201 original factory code : 360 *digital PD output directly DS.		210	S0099B-S	Adult finger clip			
				S0099C-S	Pediatric finger clip			
				S0099D-S	Adult silicone soft			
				S0099P-S	Pediatric silicone			
			360	S0099E-S	Infant silicone			
				S0099F-S	Neonate wrap(undetachable)			
				S0099G-S	Adult ear clip / Veterinary sensor			
				S0099I-S	Forehead SpO <sub>2</sub> sensor Neonate wrap sensor(detachable)			
<b>Mindray Masimo</b>	PM-6800 (masimo module, 7pin socket) , T8 Patient monitor *Need adapter cable S0126CS-L compatible with Mindray patient monitor.		0010-10-42600	S0153B-S	Adult finger clip			
				0010-10-42634	S0153C-S	Pediatric finger clip		
				S0153D-S	Adult silicone soft			
				S0153P-S	Pediatric silicone			
				S0153E-S	Infant silicone			
				S0153F-S	Neonate wrap(undetachable)			
				S0153G-S	Adult ear clip / Veterinary sensor			
				0010-10-43016	S0153I-S	Forehead SpO <sub>2</sub> sensor Neonate wrap sensor(detachable)		
<b>Konica Minolta</b>	Pulsox-300, Pulsox-300i		0010-10-42600	S0152B-S	 Adult finger clip			
				S0152D-S	 Adult silicone soft			
				S0152P-S	 Pediatric silicone			
				S0152E-S	 Infant silicone			
<b>MEK (CSI module)</b>	MP-100, MP110, MP400, MP500,MP600,MP1000			S0018B-S	Adult finger clip			
				S0018C-S	Pediatric finger clip			
				S0018D-S	Adult silicone soft			
				S0018E-S	Infant silicone			
				S0018F-S	Neonate wrap(undetachable)			
				S0018G-S	Adult ear clip / Veterinary sensor			
				S0018I-S	Forehead SpO <sub>2</sub> sensor Neonate wrap sensor(detachable)			
<b>NELLCOR (old version)</b>	<p><i>Artema:Diascope Datascope:Accutorr Plus,Expert,Passport;Dräger: Cicero,Narkomed,Vitalert 1000 GEMS:Corometrics 118,120,129,188,510,556;GEMS: Critikon 9710,9720 Plus,Compact,Dinamap Select ,MPS ,Oxyshuttle,Pro 300/400 (non-OxiMax®);GEMS:Eagle Series,Dash Se</i></p> <p><i>Philips:78352C,78354C,78834C,M1020A,M1025B,M1205A,M1350B,M1722A/B,M1732A/B,M2475B,M2601A,M3000A,M3500B,M4735A ,CMS ,Merlin Systems.V24.V26, Viridia A1, Viridia A3;Siemens:SC6000,SC7000,SC8000,SC9000XL,Sirecust 630 ,Sirecust 700,Sirem SpO2 Module; Spacelabs:</i></p>		370/048	DS-100A	S0010B-S	Adult finger clip		
				DS-YSPD	S0010C-S	Pediatric finger clip		
					S0010D-S	Adult silicone soft		
					S0010P-S	Pediatric silicone		
					S0010E-S	Infant silicone		
				D-YS	S0010F-S	Neonate wrap(undetachable)		
				D-YSE	S0010G-S	Adult ear clip sensor Veterinary SpO <sub>2</sub> sensor		
					S0010I-S	Forehead SpO <sub>2</sub> sensor Neonate wrap sensor(detachable)		
								

Reusable SpO<sub>2</sub> Sensor (need ext-cable)

Compatible Brand	Compatible Models No.	INSTRUMENT CONNECTOR	OEM P/N	REF NO.	SENSOR TYPE
<b>NELLCOR (OXI TECH)</b>	All Nellcor & Nellcor equipped OEM monitors not listed above		DS-100A	S0026B-S	 Adult finger clip
				S0026C-S	 Pediatric finger clip
				S0026D-S	 Adult silicone soft
				S0026E-S	 Infant silicone
				S0026F-S	 Neonate wrap (undetachable)
				S0026G-S	 Adult ear clip sensor Veterinary SpO <sub>2</sub> sensor
				S0026I-S	 Forehead SpO <sub>2</sub> sensor Neonate wrap sensor
<b>NELLCOR (OXI TECH)</b>	All Nellcor & Nellcor equipped OEM monitors Include N-600x Include GE Dash Series patient monitor (Oximax mould), as 1800, 2500, 3000. Include Spacelabs mCare 300 Vital Signs Monitor (Oximax mould), as 91220 series,		DS-100A	S0132B-S	Adult finger clip
				S0132C-S	Pediatric finger clip
				S0132D-S	Adult silicone soft
				S0132E-S	Infant silicone
				S0132F-S	Neonate wrap (undetachable)
				S0132G-S	Adult ear clip / Veterinary sensor
				S0132I-S	Forehead SpO <sub>2</sub> sensor Neonate wrap sensor (detachable)
<b>NIHON KOHDEN</b>	Bedside Monitor: BSM-4101,4103 4111,4113 Life scope P BSM-5105,5135 Life scope A  BSM-2351,2353 Life scope L BSM-2301,2303 Life scope I BSM-73		TL-101T	S0005B-S	Adult finger clip
				S0005C-S	Pediatric finger clip
				S0005D-S	Adult silicone soft
				S0005P-S	Pediatric silicone
				S0005E-S	Infant silicone
				S0005F-S	Neonate wrap (undetachable)
				S0005G-S	Adult ear clip / Veterinary sensor
<b>NONIN</b>	NONIN: 8500,8600,8700,8800		8000AA	S0080B-S	Adult finger clip
			8000AP	S0080C-S	Pediatric finger clip
			8000AA	S0080D-S	Adult silicone soft
			8000AP	S0080E-S	Infant silicone
				S0080F-S	Neonate wrap (undetachable)
				S0080G-S	Adult ear clip / Veterinary sensor
			<b>NOVAMETRIX</b>	Novamatrix:505,510,511,515B/C,520 7000, 7100, Oxypleth ; original match : 8776-00 Spacelabs:90351-D/G ,90465, 90466, 90467, 90489, 90651-07/08 , 90419-01, 90651A-07	
	S0062C-S	Pediatric finger clip			
	S0062E-S	Infant silicone			
	S0062F-S	Neonate wrap (undetachable)			
	S0062G-S	Adult ear clip / Veterinary sensor			
	S0062I-S	Forehead SpO <sub>2</sub> sensor Neonate wrap sensor (detachable)			
<b>NOVAMETRIX</b>	Original Part No.: 5547-32-10				
				S0143D-S	Adult silicone soft
				S0143E-S	Infant silicone
				S0143F-S	Neonate wrap (undetachable)
				S0143G-S	Adult ear clip / Veterinary sensor
				S0143I-S	Forehead SpO <sub>2</sub> sensor Neonate wrap sensor (detachable)
<b>Newtech, General Meditech Inc.</b>	Newtech:NT1, NT1A General Meditech Inc.: G1A			S0108B-S	Adult finger clip
				S0108C-S	Pediatric finger clip
				S0108D-S	Adult silicone soft
				S0108E-S	Infant silicone
				S0108F-S	Neonate wrap (undetachable)
				S0108I-S	Forehead SpO <sub>2</sub> sensor Neonate wrap sensor (detachable)

Reusable SpO<sub>2</sub> Sensor (need ext-cable)

Compatible Brand	Compatible Models No.	INSTRUMENT CONNECTOR	OEM P/N	REF NO.	SENSOR TYPE
<b>PALCO</b>	Palco: ALL	217/512 		S0079B-S	 Adult finger clip
				S0079C-S	 Pediatric finger clip
				S0079D-S	 Adult silicone soft
				S0079P-S	 Pediatric silicone
				S0079E-S	 Infant silicone
				S0079F-S	 Neonate wrap(undetachable)
				S0079G-S	  Adult ear clip sensor Veterinary SpO2 sensor
				S0079I-S	  Forehead SpO2 sensor Neonate wrap sensor
<b>PHILIPS</b>	M3,M4,MP20,MP30,MP40,MP50, MP70,MP80,VM4,VM6,VM8  *Customers from Mainland China, Bangladesh, India, Macao, Malaysia, Philippines, Pakistan, Nepal, Indonesia, South Korea, Sri Lanka, New Zealand, Thailand, and Vietnam need to order this part, please contact Philips medical system local agent.	052/060 	M1191A	S0015B-S	 Adult finger clip
			M1192A	S0015C-S	 Pediatric finger clip
			M1191A	S0015D-S	 Adult silicone soft
			M1192A	S0015P-S	 Pediatric silicone
			M1195A	S0015E-S	 Infant silicone
			M1193A	S0015F-S	 Neonate wrap(undetachable)
			M1194A	S0015G-S	  Adult ear clip sensor Veterinary SpO2 sensor
				S0015I-S	  Forehead SpO2 sensor Neonate wrap sensor
<b>SensorMedics</b>	SensorMedics:Oxyshuttle I , Oxyshuttle II, (requires adapter cable CB-A400-1003A)  GE Medical Systems: Critikon Dinamap 8700, 8710, 8720 Plus Critikon Dinamap Oxytrak (requires adapter cable CB-A400- 1027A)	527/528 	766721	S0142B-S	 Adult finger clip
				S0142C-S	 Pediatric finger clip
				S0142D-S	 Adult silicone soft
				S0142P-S	 Pediatric silicone
				S0142E-S	 Infant silicone
				S0142F-S	 Neonate wrap(undetachable)
				S0142G-S	  Adult ear clip sensor Veterinary SpO2 sensor
				S0142I-S	  Forehead SpO2 sensor Neonate wrap sensor

Disposable SpO<sub>2</sub> Sensor (need ext-cable)



Connector type

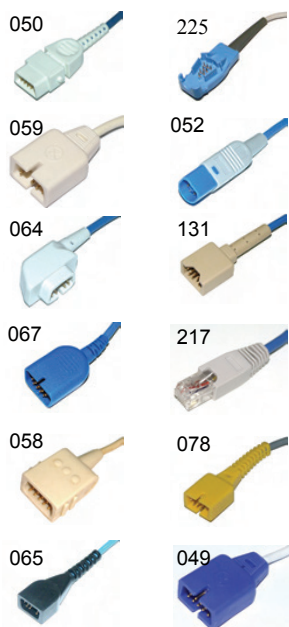

Sensor type

**S0013A Series Adult Disposable SpO2 Sensors**

Application : Adult > 30kg,  
Application site: Index or other finger

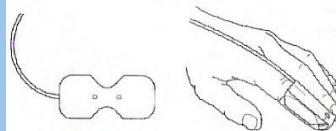

J

**S0013A Series Pediatric Disposable SpO2 Sensor**

Application: Pediatric: 10-50kg  
Application site: Index or other finger

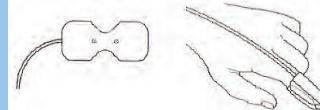

K

**S0013A Series Infant Disposable SpO2 Sensors**

Application: Infant 3~20kg  
Application site: great toe

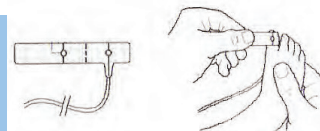

L

**S0013A Series Neonatal Disposable SpO2 Sensors**

Application: Neonatal <3 kg. Adult>40kg,  
Application site: Neonatal foot.  
Adult Index or other finger

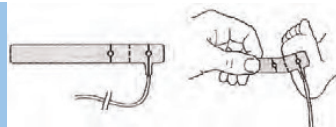

M

**Comfort (Non-adhesive) Disposable SpO2 Sensors**

Application: Neonatal <3 kg. Adult>30kg,  
Application site: Neonatal foot.  
Adult Index or other finger.  
Soft biomedical comfortable foam material & Velcro



N

Medical grade application

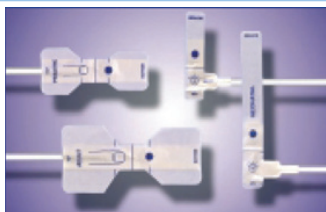

Microfoam (standard)

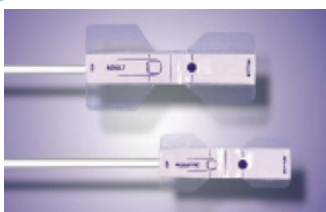



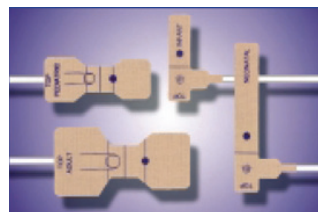









Transpore (Adult & Pediatric only)



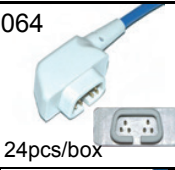
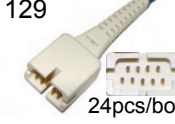





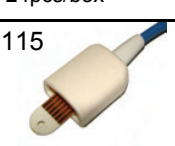











Medaplast

Notice: for Transpore or Medaplast tape, please indicated on your orders as follows: T=Transpore, e.g. S0010J-ST; P=Medaplast, e.g. S0010J-SP

Disposable SpO<sub>2</sub> Sensor (need ext-cable)

Compatible Brand	Compatible Models No.	INSTRUMENT CONNECTOR	OEM P/N	REF NO.	SENSOR TYPE
<b>BCI</b> (Biochem International)	<b>BCI(Biochem International):</b> 3401,3304,3303,3302,3301,3300; Spacelabs Burdick: PRO2; Dräger: Dräger Oxipac 2000	 24pcs/box		S0076J-S	 Adult Disp. SpO2 Sensor
				S0076K-S	 Pediatric Disp. SpO2 Sensor
				S0076L-L	 Infant Disp. SpO2 Sensor
				S0076M-L	 Neonatal Disp. SpO2 Sensor
				S0076N-L	 Comfort Disp. SpO2 Sensor
<b>CSI</b> Criticare Systems International	Alaris(IVAC):VitalCheck 4400,CSI:503DX,503Spot,504DX,506, 506DX,507ELC2 ScholarIII,8100Poet Plus,Poet (602-3A) (Sensor + Cable),Scholar (Sensor + Cable)	 24pcs/box		S0044J-S	Adult Disposable SpO2 Sensor
				S0044K-S	Pediatric Disposable SpO2 Sensor
				S0044L-L	Infant Disposable SpO2 Sensor
				S0044M-L	neonatal Disposable SpO2 Sensor
				S0044N-L	Comfort Disposable SpO2 Sensors
<b>DATASCOPE</b>	Datascop:Accutorr 3/4 SAT, Accutorr Plus,Passport (Database SpO2),Compatible for 0020-00-071-01	 24pcs/box		S0052K-S	Pediatric Disposable SpO2 Sensor
				S0052M-L	neonatal Disposable SpO2 Sensor
<b>DATEX</b>	AS/3,CS/3,CH/S,CH/2S,CH- RS,CG/2S,Cardiicap I,Cardiicap II,Cardiicap 5,Capnomac Ultima,Light Monitor,M-Estpr,Oscar II,OSP-200,Satlite Trans,Satlite,Trans Plus,System 5,ULTS00,ULTSIO,ULTSVI,ULTSVO, original factory code :SAF-F4	 24pcs/box		S0036J-S	Adult Disposable SpO2 Sensor
				S0036K-S	Pediatric Disposable SpO2 Sensor
				S0036L-L	Infant Disposable SpO2 Sensor
				S0036M-L	neonatal Disposable SpO2 Sensor
				S0036N-L	Comfort Disposable SpO2 Sensors
<b>OHMEDA</b> (Adaptor required: S0014BC-L)	(Need adapter cable S0014BC-L) DateX-Ohmeda:3740,3710,4700 OxiCap,5250RGM, Biox3760,Ohmeda3700,3770,3775,Rascal II, GE:7000Series,Corometrics511, TRAM A.R, TRAM Modular x00SL Series, as200SL,400SL,600SL,800A,800SL,Mennen :Horizon XL800 (Ohmeda SpO2)	 24pcs/box		S0014J-S	Adult Disposable SpO2 Sensor
				S0014K-S	Pediatric Disposable SpO2 Sensor
				S0014L-L	Infant Disposable SpO2 Sensor
				S0014M-L	neonatal Disposable SpO2 Sensor
				S0014N-L	Comfort Disposable SpO2 Sensors
<b>OHMEDA</b>	DateX-Ohmeda:3740, 3710, only use for Ohmeda oximeter, EMITTER: 660/905/940-4	 24pcs/box	OXY-AP	S0123J-S	Adult Disposable SpO2 Sensor
				S0123K-S	Pediatric Disposable SpO2 Sensor
				S0123L-L	Infant Disposable SpO2 Sensor
			OXY-AF	S0123M-L	neonatal Disposable SpO2 Sensor
				S0123N-L	Comfort Disposable SpO2 Sensors
<b>DOLPHIN (OSI)</b>	Dolphin ONE Oximeters, *digital PD output directly DS. Copatible original : 360	 24pcs/box		S0099J-S	Adult Disposable SpO2 Sensor
				S0099K-S	Pediatric Disposable SpO2 Sensor
				S0099L-L	Infant Disposable SpO2 Sensor
				S0099M-L	neonatal Disposable SpO2 Sensor
				S0099N-L	Comfort Disposable SpO2 Sensors
<b>GMI</b> (General Meditech,Inc) Creative	<b>GMI :</b> G2A Vital Signs Monitor G3D, G3A, G3C Patient monitor G3D, G3F, G3G Patient monitor G3H Patient monitor <b>Creative:</b> *digital PD output directly DS. PC-900, PC-900A, PC-900Color PC-3000 Patient Monitor	 24pcs/box		S0108M-LP	neonatal/Adult Disposable SpO2 Sensor
				S0108N-LC	neonatal Disposable SpO2 Sensor
<b>Masimo</b> * Original	Redical			LNOP-ADT	Adult Disposable SpO2 Sensor
				LNOP--PDT	Pediatric Disposable SpO2 Sensor
				LNOP-NeoPT	neonatal Disposable SpO2 Sensor
				LNOP-NEO	Bridge Disposable SpO2 Sensor
				LNOP-Neo-L	neonatal / Adult Disposable SpO2 Sensor
				LNOP-NeoPT-L	Neonatal Disposable SpO2 Sensor

Disposable SpO<sub>2</sub> Sensor (need ext-cable)

Compatible Brand	Compatible Models No.	INSTRUMENT CONNECTOR	OEM P/N	REF NO.	SENSOR TYPE
<b>Mindray Masimo</b>	PM-6800 (masimo module, 7pin socket) , T8 Patient monitor *Need adapter cable S0126CS-L compatible with Mindray patient monitor.	 24pcs/box	0010-10-42630	S0153J-S	 Adult Disp. SpO <sub>2</sub> Sensor
			0010-10-42629	S0153K-S	 Pediatric Disp.SpO <sub>2</sub> Sensor
			0010-10-42628	S0153L-L	 Infant Disp. SpO <sub>2</sub> Sensor
			0010-10-42627	S0153M-L	 Neonatal Disp.SpO <sub>2</sub> Sensor
				S0153N-L	 Comfort Disp.SpO <sub>2</sub> Sensor
<b>NELLCOR, Charmcare</b>	Nellcor®:N100 (req. preamp cable),N180,N200 (req. preamp cable),N-20,NPB-40,NPB-75,NPB-290/5 ,N-390,N-395,N-3000,N-6000	 24pcs/box	D25	S0010J-S	 Adult Disp. SpO <sub>2</sub> Sensor
			D20	S0010K-S	 Pediatric Disp.SpO <sub>2</sub> Sensor
			I20	S0010L-L	 Infant Disp. SpO <sub>2</sub> Sensor
			N25	S0010M-L	 Neonatal Disp.SpO <sub>2</sub> Sensor
				S0010N-L	 Comfort Disp.SpO <sub>2</sub> Sensor
<b>NELLCOR OXI-TECH</b>	All Nellcor & Nellcor equipped OEM monitors not listed above	 24pcs/box	MAX-A	S0026J-S	Adult Disposable SpO <sub>2</sub> Sensor
			MAX-P	S0026K-S	Pediatric Disposable SpO <sub>2</sub> Sensor
			MAX-I	S0026L-L	Infant Disposable SpO <sub>2</sub> Sensor
			MAX-N	S0026M-L	neonatal Disposable SpO <sub>2</sub> Sensor
				S0026N-L	Comfort Disposable SpO <sub>2</sub> Sensors
<b>NELLCOR OXIMAX (Original)</b>	All Nellcor & Nellcor equipped OEM monitors Include N-600x Include GE Medical Dash2500,3000)	 24pcs/box	MAX-A	MAX-A	Adult Disposable SpO <sub>2</sub> Sensor
			MAX-P	MAX-P	Pediatric Disposable SpO <sub>2</sub> Sensor
			MAX-I	MAX-I	Infant Disposable SpO <sub>2</sub> Sensor
			MAX-N	MAX-N	neonatal Disposable SpO <sub>2</sub> Sensor
<b>NIHON KOHDEN</b>	Bedside Monitor: BSM-4101,4103, 4111,4113 Life scope P, BSM-5105,5135 Life scope A, BSM-2351,2353 Life scope L, BSM-2301,2303 Life scope I	 24pcs/box		S0005J-S	Adult Disposable SpO <sub>2</sub> Sensor
				S0005K-S	Pediatric Disposable SpO <sub>2</sub> Sensor
				S0005L-L	Infant Disposable SpO <sub>2</sub> Sensor
				S0005M-L	neonatal Disposable SpO <sub>2</sub> Sensor
				S0005N-L	Comfort Disposable SpO <sub>2</sub> Sensors
<b>NONIN</b>	NONIN: 8500,8600,8700,8800	 24pcs/box	7000A	S0080J-S	Adult Disposable SpO <sub>2</sub> Sensor
				S0080K-S	Pediatric Disposable SpO <sub>2</sub> Sensor
				S0080L-L	Infant Disposable SpO <sub>2</sub> Sensor
				S0080M-L	neonatal Disposable SpO <sub>2</sub> Sensor
				S0080N-L	Comfort Disposable SpO <sub>2</sub> Sensors
<b>NOVANMETRIX</b>	Novamatrix:505,510,511,515B/C,520700,7100,Oxypleth; original match : 8776-00; Spacelabs:90351D/G,90465,90466,90467,90489,90651-07/08,90419-01,90651A-07,original match:8776-00	 24pcs/box		S0062J-S	Adult Disposable SpO <sub>2</sub> Sensor
				S0062K-S	Pediatric Disposable SpO <sub>2</sub> Sensor
				S0062L-L	Infant Disposable SpO <sub>2</sub> Sensor
				S0062M-L	neonatal Disposable SpO <sub>2</sub> Sensor
				S0062N-L	Comfort Disposable SpO <sub>2</sub> Sensors
<b>PALCO</b>	Palco: ALL	 24pcs/box		S0079J-S	Adult Disposable SpO <sub>2</sub> Sensor
				S0079K-S	Pediatric Disposable SpO <sub>2</sub> Sensor
				S0079L-L	Infant Disposable SpO <sub>2</sub> Sensor
				S0079M-L	neonatal Disposable SpO <sub>2</sub> Sensor
				S0079N-L	Comfort Disposable SpO <sub>2</sub> Sensors

## SpO<sub>2</sub> Sensor Extension Cable

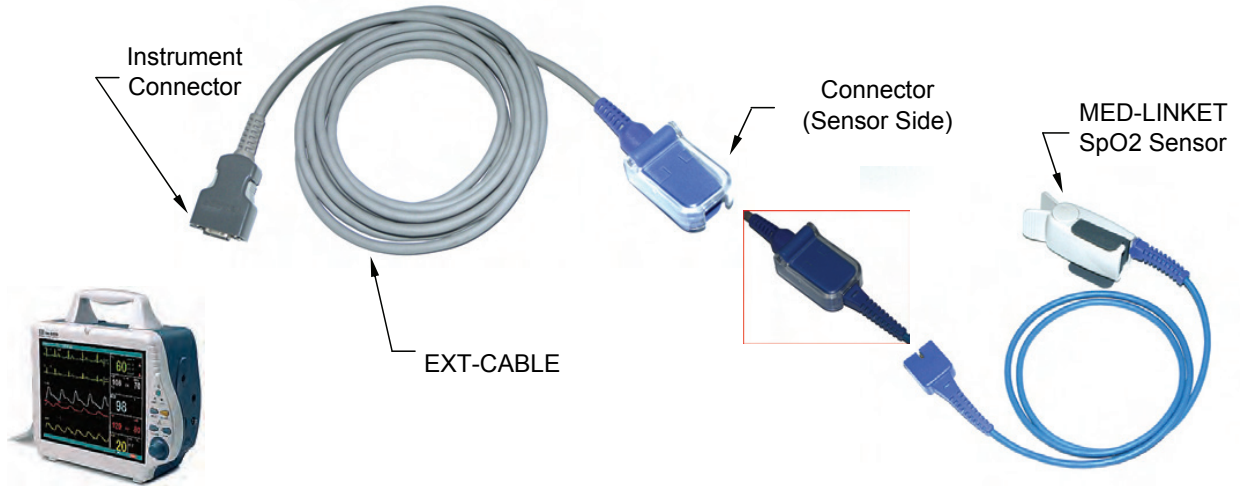

### Instrument Connector

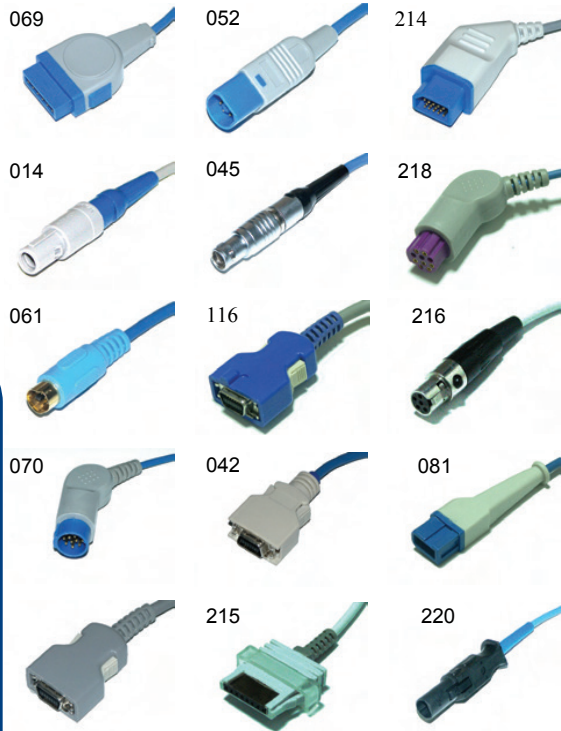

### Connector(Sensor side)

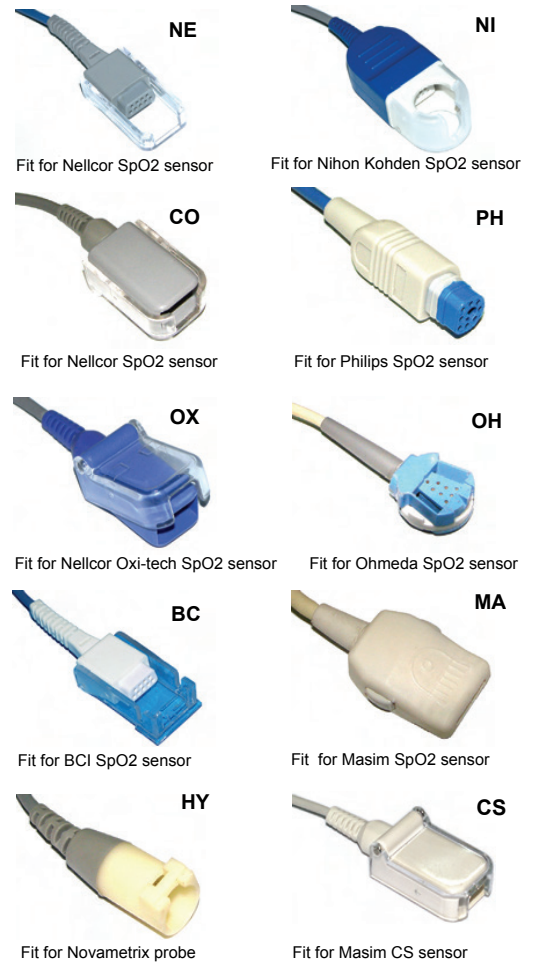













SpO<sub>2</sub> Sensor Extension Cable

Compatible Brand	Compatible Models No.	OEM P/N	REF NO.	Description (Name,Length,Plug,Compatible)	INSTRUMENT CONNECTOR	CONNECTOR (SENSOR SIDE)
<b>BCI</b>	<b>(Biochem International):</b> 3401,3304,3303,3302,3301,3300;		S0076BC-L	Exi-Cable,8ft,DB9M>DB9F, Suitable for BCI probe	389	
	<b>(Biochem International):</b> 6100, 9100, Advisor, Autocorr, Mini Torr BCI (Biochem International), Mini Torr Plus;		S0111BC-L	Exi-Cable,8ft, Readel 1bit.7P>DB9F, Suitable for BCI probe	558	
<b>Bionet (Korea)</b>	BM3,BM3 Plus;		S0121BC-L	Exi-Cable,8ft, AMP 6P>DB9F, Suitable for Bionet probe	725	
	BM3Vet, BM31;		S0084BC-L	Exi-Cable,8ft, Readel 1bit.7P>DB9F, Suitable for Bionet probe	609	
<b>Biosys (Korea)</b>	BPM300		S0065NE-L	Exi-Cable,8ft, MD6M>DB9F, Suitable for Nellcor probe	061	130
<b>Bruker (ODAM)</b>	Bruker (Odam) all		S0071BC-L	Exi-Cable,8ft, Round12P>DB9F, Suitable for BCI probe	721	
<b>Colin</b>	Datascope:Accutorr Plus, Nellcor:NPB-290/5, N-390,N-395,N-3000 N-6000,NPB-290/5,N-390,N-395,N-3000,N-6000, Nihon Kohden:BSM-4104A, BSM-4114A, Colin BP88/306, Need S0008CO-L(Rev.C) to compatible with Pro1000(OXIMAX)	SCP-10	S0008CO-L	Exi-Cable,8ft, AMP14P>DB9F, Suitable for Nellcor probe, as S0010B-S,S0026B-S	116	127
<b>Corpuls</b>	 Corpuls 08/16, 08/16M;		S0138CO-L	Exi-Cable,8ft, Readel 2bit.6P>DB9F, Compatible for NELLCOR sensor and MED-LINK S0010B-S	773	480
			S0138CS-L	Exi-Cable,8ft, Readel 2bit.6P>DB9F, Suitable for Masimo CS Sensor and MED-LINK S0153B-S	749	479
<b>CSI</b>	CSI (Criticare Systems International):506 Spot CSI ,507SD(Criticare Systems International):503 Spot;		S0044BC-L	Exi-Cable,8ft, DB9M>DB9F, Suitable for CSI probe	064	
	CSI (Criticare Systems International):Scholar , Poet (602-3A), 1100 , 581, 508, 507, 507SD,504, 503, 501; Mindray 500A;		S0100BC-L	Exi-Cable,8ft, Lemo 1B.5>DB9F, Suitable for CSI probe instead of S0011NE-L	454	
<b>Datascope</b>	Datascope:Accusat Datascope:Accutorr 3/4 SAT Datascope:Accutorr Plus (Datascope Sp02) Datascope:Passport (Database Sp02);		S0052BC-L	Exi-Cable,8ft, DIN8P>DB9F, Suitable for Datascope probe	722	
<b>PETAS</b>			S0089BC-L	Exi-Cable,8ft, Readel 2Rib 40°-6P>DB9F, fit for Nellcor probe		130

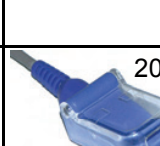

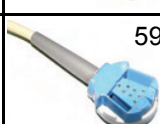
SpO<sub>2</sub> Sensor Extension Cable

OEM	OEM MODELS NUMBER	OEM P/N	REF NO.	Description (Name,Length,Plug,Compatible)	INSTRUMENT CONNECTOR	CONNECTOR (SENSOR SIDE)
<b>DATEX</b>	Datex-Ohmeda:AS/3, CS/3, CH/S, CH/2S, CH-RS, CG/2S, Cardiocap I, Cardiocap II, Cardiocap 5, Capnomac Ultima, Light Monitor, M-Estrp, Oscar II, OSP-200, Satellite Trans, Satlite Trans Plus, ULTSVI, ULTSVO, ULTSIO, ULTS00;	OXY-C3	S0036BC-L	Exi-Cable,8ft, Round 10J>DB9F, Suitable for DATEX probe	718 	
		OXY-SL3	S0036OH-L	Exi-Cable,8ft, Round 10J>8J, Suitable for DATEX probe	343 	396 
<b>Datex-Ohmeda</b>	Suitable for Datex-Ohmeda:Ohmeda 3700, Ohmeda 3710, Ohmeda 3770, Ohmeda 3775, Biox 3740, Biox 3760, 3800 OxiCap, 4700 OxiCap, 5250RGM, Rascal II; GE Medical Systems:Corometrics 511; Mennen:Horizon XL (Ohmeda SpO2);		S0014BC-L	Exi-Cable,8ft, Hyc7P>DB9F, Suitable for Ohmeda probe	511 	
		OXY-OL3	S0014OH-L	Exi-Cable,8ft, Hyc7P>8J, Suitable for Ohmeda probe	754 	396 
<b>GE-Ohmeda</b>	Sensor solutions for GE Ohmeda TruSat™ pulse oximeter;	OXY-MC3	S0127OH-L	Interconnect cable,8ft DB9M>8J, Suitable for Ohmeda probe	592 	352 
<b>Dolphin Medical (OSI)</b>	Dolphin ONE Oximeters;	110	S0099BC-L	Exi-Cable,8ft, AMP14P>DB9F, Suitable for Dolphin probe	388 	
<b>EDAN (China)</b>	EDAN: M9, WANDONG 万东: BYS-8000, MINDRAY 迈瑞: PM-8000 MEC1200;		S0040BC-L	Exi-Cable,8ft, Readel 2bit.6P>DB9F, Suitable for BCI probe	076 	
<b>GE Medical (Nellcor module)</b>	Dash 2000/3000/4000 with Nellcor option,Dash 3000/4000/5000 with Ohmeda option, Solar 8000/8000M, i/9500 with Tram Module 451/451N/851/851N, CardioLab@/Mac-Lab@with Tram Module 451/451N Corometrics® 120/2120 series Eagle 1000/3000/4000 Responder 3000 with Nellcor option;	2006644-001	S0002NE-L	Exi-Cable,8ft, Rectangle 11P>DB9F, Compatible for NELLCOR sensor and MED-LINK S0010B-S	075 	130 
<b>GE Medical (Oxi-tech module)</b>	Dash 3000/4000/5000 with Nellcor OxiMax option Solar 8000/8000M, i9500 with Tram module 451N5/851N5;	202140-6-001	S0122OX-L	Exi-Cable,8ft, Rectangle 11P>>DB9F, Suitable for DS-100A S0132B-S, and S0010B-S(Need S0026NE-A)	075 	205 
<b>GE Medical (Masimo module)</b>	Dash 3000/4000/5000 with Masimo option Solar 8000/8000M, i/9500 with Tram Module 451M/851M CardioLab@/Mac-Lab@ with Tram Module 451M Corometrics® 259;	201700-2-003	S0025MA-L	Exi-Cable,8ft, Rectangle 11P>Masimo 6J, Suitable for Masimo LNOP probe	075 	109 
			S0025CO-L	Exi-Cable,8ft, Rectangle 11P>DB9F, Compatible for NELLCOR sensor and MED-LINK S0010B-S	069 	
<b>GE-Ohmeda</b>	S/5, i4 Modular Monitors with E-series modules Corometrics® 259 with TruSignal Ohmeda Technology;	OXY-ES3	S0128OH-L	Interconnect cable,8ft, Rectangle 11P>8J, Suitable for Ohmeda probe	379 	591 



SpO<sub>2</sub> Sensor Extension Cable

www.bmtmedikal.com.tr

Compatible Brand	Compatible Models No.	OEM P/N	REF NO.	Description (Name,Length,Plug,Compatible)	INSTRUMENT CONNECTOR	CONNECTOR (SENSOR SIDE)
<b>Hellige</b>	Servomed 4.Generation SCP 844,851, 852; SCS 804; SMK151,153,154, 155-1,156,157,SMK181,182,SMV 104T,107,111,168;SMS316;SMC108; SMV104,Servomed N4, Servocard, Serie Cardioserv,Vicom SM,SMU 511,611,612,630 Serie SMK-200, SMK210,211,230,231,240,250, SMP 300,310,Pepita 201,202,202 R, ,203,Pepita 203, R204,204R,205, Pepita 205R		S0006NE-L	Exi-Cable,8ft, Round 10P>DB9F, fit for Nellcor probe		
<b>Huntleigh Healthcare</b>			S0147NE-L	Exi-Cable,8ft, Readel 1bit.7P>DB9F, Suitable for BCI probe		
<b>INVIVO (Nellcor module)</b>	4500,4500Plus,Millenia,Omeg a1445,Omni-TrakTVS,Sat Scout,original cable number 9383;		S0083NE-L	Exi-Cable,8ft, Lemo 1B.7p>DB9F, Suitable for Nellcor probe		
<b>INVIVO (Masimo module)</b>	M8;		S0094MA-L	Exi-Cable,8ft, Lemo 1B.7p>Masimo 6J, Suitable for Masimo LNOP probe		
			S0094CO-L	Exi-Cable,8ft, Lemo 1B.7p>DB9F, Compatible for NELLCOR sensor and MED-LINK S0010B-S		
<b>Kontron</b>	Kontron:7840 Kontron:7845 Kontron:Kolormon Kontron:Micromon Kontron:Minimon 7137 Kontron:Supermon Kontron:Trakmon;		S0019NE-L	Exi-Cable,8ft, Round 12P>DB9F, Suitable for Nellcor probe		
<b>Masimo</b>	Masimo all MDE:EscortII OPT30:Prism ,GE Marquette:,Pro1000,V300 , INVIVO:T8 , Schiller: , ZOLL: , Datascope: Trio,Passport2, Spectrum, (Must be Masimo Module);		S0020CO-L	Exi-Cable,8ft, Amp14P>DB9F, Compatible for NELLCOR sensor and MED-LINK S0010B-S		
			S0153NE-A	Adapter, DB9M>DB9F, Compatible for NELLCOR sensor and MED-LINK S0010 Series		
<b>MEK (Korea)</b>	MP-100, MP110, MP400, MP500,MP600,MP1000 (CSI Module);		S0018BC-L	Exi-Cable,8ft, DB9M>DB9F, Suitable for MEK probe		
	REF: MIS3AH_1 MEK ICS: MP1000NT TYPE: MEK (CSI Module);	MIS3AH_1	S0115BC-L	Exi-Cable,8ft, Round 8p>DB9F, Suitable for MEK probe		
	MP1000, (Nellcor Module);		S0144NE-L	Exi-Cable,8ft, Round 8p>DB9F, Suitable for Nellcor probe		













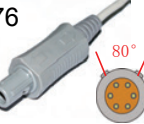











### SpO<sub>2</sub> Sensor Extension Cable



Compatible Brand	Compatible Models No.	OEM P/N	REF NO.	Description (Name,Length,Plug,Compatible)	INSTRUMENT CONNECTOR	CONNECTOR (SENSOR SIDE)
<b>Mennen</b>			S0103NE-L	Exi-Cable,8ft, Round 8p>DB9F, Suitable for Nellcor probe	213	130
	Horizon2000;		S0009NE-L	Exi-Cable,8ft, Lemo 2b. 10P>DB9F, Suitable for Nellcor probe	499	130
<b>Mindray (csi module)</b>	MEC-509,509+,503,507, OEM No.512A-30-06074;		S0011CS-L	Exi-Cable,8ft, Lemo 1B.5p>DB9F, Suitable for CSI probe	451	508
<b>Mindray (mindray module)</b>	VS800(Mindray module), PM-7000,6201,8000,9000, Marketing:SFDA,CE,FDA; OEM No.0010-20-42594 MEC1200;	0010-20-42594	S0040NE-L	Exi-Cable,8ft, Redel 2bit-40° 6p>DB9F, Compatible for NELLCOR sensor and MED-LINK S0010B-S, Mindray 512D,	076	205
	PM5000,PM6000,PM8100 Marketing:SFDA,CE. OEM No.0010-21-11957	0010-21-11957	S0045OX-L	Exi-Cable,8ft, Round 12p>DB9F, Compatible for NELLCOR sensor and MED-LINK S0010B-S	566	205
	PM-6800, (Mindray module) BeneView T5/T6/T8 (Mindray module) iPM Series (Mindray module) ;	0010-30-42737	S0125CO-L	Exi-Cable,8ft, Round 7p>DB9F, Compatible for NELLCOR sensor and MED-LINK S0010B-S	239	205
<b>Mindray (Masimo module)</b>	PM9000express(.Masimo). PM8002,9201, (PM-6201,7000,8000,M1K0,M2K0 since 2006), Marketing:SFDA,CE.FDA ;	0010-30-42625	S0116CO-L	Exi-Cable,8ft, Radel 2bit-60°6p,>>DB9F, Compatible for NELLCOR sensor and MED-LINK S0010B-S	241	
	PM-9000,9100,9200,(PM-6201,7000,8000,M1K0,M2K0 before 2006) Marketing:SFDA,CE.FDA OEM No.0010-30-42602;	0010-30-42602	S0013CO-L	Exi-Cable,8ft, Radel 2bit 40° 6p>DB9F, Compatible for NELLCOR sensor and MED-LINK S0010B-S	076	
	PM-6000 ( masimo module, 12pin socket) Marketing:SFDA,CE.FDA OEM No.0010-30-12452;	0010-30-12452	S0012CO-L	Exi-Cable,8ft, Round 12p>DB9F, Compatible for NELLCOR sensor and MED-LINK S0010B-S	412	
	PM-6800 (masimo module, 7pin socket) , BeneView T5/T6/T8 (Masimo module) iPM Series (Masimo module) ;	0010-30-42738	S0126CO-L	Exi-Cable,8ft, Round 7p>DB9F, Suitable for NELLCOR probe,, as S0010B-S	772	
	PM-6800 (masimo module, 7pin socket) , BeneView T5/T6/T8 (Masimo module) iPM Series (Masimo module) ;	0010-30-42738	S0126CS-L	Exi-Cable,8ft, Round 7p>DB9F, Suitable for Masimo CS probe and MED-LINK S0153B-S	771	480
	MINDRAY T5,T8;	0010-20-42712	S0126OX-L	Nellcor OxiMax SpO2 Cable,8ft, Round 8p>DB9F, Suitable for Masimo CS probe and MED-LINK S0026B-S		205
	PM9000express, PM9000, 9100, 9200 (masimo module) Marketing:SFDA,CE.FDA;		S0013MA-L	Exi-Cable,8ft, Radel 2bit 6p>Masimo 6J, Suitable for Masimo probe	402	109















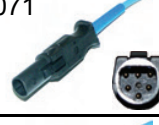

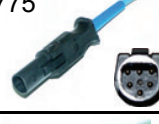



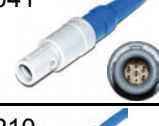

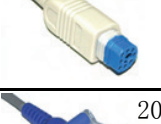

SpO<sub>2</sub> Sensor Extension Cable

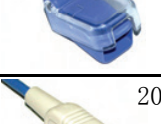
Compatible Brand	Compatible Models No.	OEM P/N	REF NO.	Description (Name,Length,Plug,Compatible)	INSTRUMENT CONNECTOR	CONNECTOR (SENSOR SIDE)
<b>Mindray (Masimo module)</b>	PM6000 (masimo module) Marketing:SFDA,CE,FDA OEM No.6200-30-11721;	6200-30-11721	S0012MA-L	Exi-Cable,8ft, Round 12p>Masimo 6J, Suitable for Masimo probe	 505	 109
<b>MINDRAY (Nellcor module)</b>	VS800, 8002, 9201, PM7000(Since Jan. 2006) patient monitor of Nellcor module and 6pin plug (80° between 2bit);	0010-20-42595(E)	S0129NE-L	Exi-Cable,8ft, Readel 2bit 6p (80°)>>>DB9F, Suitable for Nellcor probe	 076	 544
<b>Nellcor</b>	Datascope:Accutorr Plus, Nellcor:NPB-290/5, N-390,N-395,N-3000 N-6000,NPB-290/5,N-390,N-395,N-3000,N-6000, Nihon Kohden:BSM-4104A, BSM-4114A, Colin BP88/306, Need S0008CO-L(Rev.C) to compatible with Pro1000(OXIMAX)	SCP-10	S0001NE-L	Exi-Cable,8ft, AMP14P>DB9F, Suitable for Nellcor probe	 388	 130
<b>Nellcor</b>	Datascope:Expert,Passport, GE Medical:Corometrics 188/129,CritikonDinamap9700/9710/9720 Plus/Compact/MPS/Pro 300/Pro 400/Select, IvyBiomedical:405P,405T, M.D.E.:Escort II OPT30,Prism, Nellcor:N100,N200,N180,N-20,NPB-40,NPB-75,Nonin:8500,8604, Welch Allyn Protocol:Propaq 206-EL,Propaq 204-EL,Propaq 202-EL,Propaq 106EL;	EC-4	S0010NE-S	Exi-Cable,4ft, DB9M>DB9F, Suitable for Nellcor probe	 059	 130
		EC-8	S0010NE-L	Exi-Cable,8ft, DB9M>DB9F, Suitable for Nellcor probe	 059	 130
<b>Nellcor (Oxi-tech)</b>	Nellcor: N550, N-595 GE: Dinamap PRO (w/Oxi) , Schiller,Include N-600x, GE Dash Series patient monitor (Oximax mould), as 1800, 2500, 3000. CARESCAPE. Include Spacelabs mCare 300 Vital Signs Monitor(Oximax mould), as 91220 series;		S0026NE-A	OXI Adapter DB9M>DB9F, Suitable for Nellcor probe, Old Nellcor to OXIMA TECH OXIMETER	 496	
	All Nellcor & Nellcor equipped OEM monitors not listed above , <b>Philips</b> : Viridia A3;	DEC-4	S0026OX-S	Exi-Cable,4ft, DB9M>DB9F, Suitable for Nellcor oximax probe , as S0026B-S	 204	 238
		DEC-8	S0026OX-L	Exi-Cable,8ft, DB9M>DB9F, Suitable for Nellcor oximax probe and MED-LINK S0026B-S	 204	 238
	Nellcor: N550,N560, N-595 GE: Dinamap PRO (w/Oxi) , Schiller;	DOC-10	S0117OX-L	Exi-Cable,8ft, AMP14P>DB9F, Suitable for Nellcor probe and MED-LINK S0026B-S	 116	 205
<b>Nihon Kohden</b>	Compatibilities : Be Compatible with Nihon Kohden OPV-1500 , OPV-3100;	JL-302T	S0159NI-L	Exi-Cable,8ft, 3M 20p>DB9F, Suitable for Nihon Kohden probe TL-201T and Med-linket S0005 Series probe	 090	
			S0069NI-L	Exi-Cable,8ft, Round 10p>DB9F, Suitable for Nihon Kohden probe and Med-linket S0005 Series probe	 047	
	Bedside Monitor: BSM-4101,4103,4111,4113 Life scope P,BSM-5105,5135 Life scope A,BSM-2351,2353 Life scope L,BSM-2301,2303 Life scope I	JL-900P	S0005NI-L	Exi-Cable,8ft, Rectangle 14p>DB9F, Suitable for Nihon Kohden probe and S0005 Series probe	 214	 090

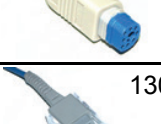
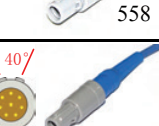
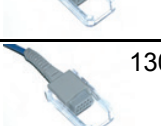
## SpO<sub>2</sub> Sensor Extension Cable



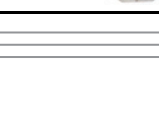
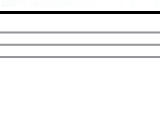

















OEM	OEM MODELS NUMBER	OEM P/N	REF NO.	Description (Name,Length,Plug,Compatible)	INSTRUMENT CONNECTOR	CONNECTOR (SENSOR SIDE)
Nonin	8604,8604D;		S0080NE-L	Exi-Cable,8ft, Lemo 1b 6p>DB9F, Suitable for Nonin probe	045 	130 
	8600 series, 8500,8700,8800,9600,9700; 		S0109NE-L	Exi-Cable,8ft, AMP 8p>DB9F, Suitable for Nonin probe	215 	130 
Novamatrix	Novamatrix:505, 510,511,515B/C, 520, 7000, 7100, Oxypleth ; Spacelabs Medical:90351-D/G , 90465 , , 90466, 90467, 90489, 90651-07/08 , 90419-01, 90651A-07;	8776-00	S0062NE-L	Exi-Cable,8ft, Hypertronics 7p>DB9F, Suitable for Novamatrix probe and MED-LINK S0062B-S	071 	130 
Novamatrix	Oxypleth (Extension Cable),7100 (Extension Cable),7000 (Extension Cable),520 (Extension Cable),515B/C (Extension Cable) ,505 (Extension Cable),500;		S0062HY-L	Exi-Cable,8ft, Hypertronics 7p>Hys 7J, Suitable for Novamatrix probe and MED-LINK S0062B-L	775 	326 
Pace Tech Generra	Pace Tech:All w/ black face (except Vitalmax 800 w/Nellcor® SpO2), Genera: 710, 200, 300, 400, 810, 530;	4510	S0082BC-L	Exi-Cable,8ft, Switchcraft 5J>DB9F, Suitable for BCI probe	216 	
			S0091BC-L	Exi-Cable,8ft, Readel 1bit 7p>DB9F, Suitable for BCI probe	041 	
Philips	Philips Medical:M2601A,M3000A,M3 500B,M4735A;	M1943A	S0015OX-L	Exi-Cable,8ft, hemicycle 8p>DB9F, Compatible for NELLCOR sensor and MED-LINK S0010B-S	210 	205 
	Philips Medical:M2601A,M3000A,M3 500B,M4735A;	M1941A	S0015PH-L	Exi-Cable,8ft, hemicycle8P>hemicycle 8J, Suitable for Philips probe	210 	080 
	Philips Medical:78352C,78354C,78834C, M1020A,M1025B,M1205A,M1350 B,M1722A/B,M1732A/B,M2475B, Viridia A1,Viridia A3;	M1900B	S0003OX-L	Exi-Cable,8ft, Round 12p>DB9F, Compatible for NELLCOR sensor and MED-LINK S0010B-S	128 	205 
	Philips Medical:M2475B, M1732A/B, M1722A/B, M1020A, 78833C, 78833A, 78834A, 78352C, 78352A;	M1940A	S0003PH-L	Exi-Cable,8ft, Round 12P>hemicycle 8J, fit for Philips probe	206 	207 
PRIMEDIC			S0139NE-L	Exi-Cable,8ft, Redel 1Rib-7pin>DB9F, Fit for Nellcor probe	 558	130 
			S0140NE-L	Exi-Cable,8ft, Redel 2Rib-8pin>DB9F, Fit for Nellcor probe	 40/	130 
S&W (Artema)	S&W Artema Patient monitor;	SL033057	S0023OX-L	Exi-Cable,8ft, Round 10J>DB9F, Fit for Nellcor and S0010 Series SpO2 sensors	209 	205 
S&W Athena and Diascope	S&W Athena and Diascope;		S0156NE-L	Exi-Cable,8ft, Round 10J>DB9F, Fit for Nellcor and S0010 Series SpO2 sensors		130 

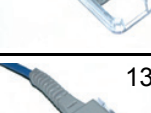
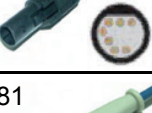
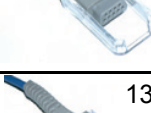
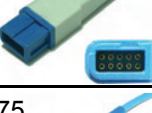

SpO<sub>2</sub> Sensor Extension Cable

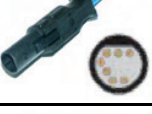
www.bmtmedikal.com.tr

Compatible Brand	Compatible Models No.	OEM P/N	REF NO.	Description (Name,Length,Plug,Compatible)	INSTRUMENT CONNECTOR	CONNECTOR (SENSOR SIDE)
<b>Schiller (nellcor module)</b>	Schiller Argus TM-7;		S0028NE-L	Exi-Cable,8ft, Din7P>DB9F, fit for Nellcor probe	 339	 130
<b>Schiller (Masimo module)</b>	Argus Pro, Argus LCM;		S0118MA-L	Exi-Cable,8ft, DIN7P>Masimo 6J, Suitable for Masimo probe	 339	 109
<b>SIMED (Baxter)</b>	Baxter:ASAT , SiMED:S-50 SiMED:S-100, SiMED:S-100e;	600015	S0120NE-L	Exi-Cable,8ft, Hypertronics 8p>DB9F, Compatible for NELLCOR sensor and MED-LINK S0010B-S	 447	 130
<b>Siemens Drager medical</b>	Siemens medical SC 6002XL, SC7000, SC8000, SC9000XL;		S0072BC-S	Exi-Cable,4ft, round 7P>DB9F, Suitable for NELLCOR DS-100A or MED-LINK S0010 Series	 073	
	Siemens medical SC 6002XL, SC7000, SC8000, SC9000XL;		S0072BC-L	Exi-Cable,8ft, round 7P>DB9F, Suitable for NELLCOR DS-100A or MED-LINK S0010 Series	 073	
	Drager medical: Vitalert 1000, Cicero;		S0119NE-L	Exi-Cable,8ft, Lemo 2b 8P>DB9F, Suitable for Nellcor probe	 046	 130
	Siemens Medical:Sirecust 700 Siemens Medical:Sirecust 630 Siemens Medical:Sirem SpO2 Module ;		S0078NE-L	Exi-Cable,8ft, hemicycle10P>DB9F, Suitable for Nellcor probe	 476	 130
	Spacelabs Medical:90351-0/6; 90465; 0466; 90489; 90651A-08; 90651-A; IM77,90308, PC Scout;	700-0020-0	S0035NE-L	Exi-Cable,8ft, Hypertronics 12p>DB9F, Suitable for Nellcor probe	 220	 130
Spacelabs Medical: 1050,1600,1700,90369,90469 ,90496 Ultraview;	700-0030-00	S0004NE-L	Exi-Cable,8ft, Rectangle 10P>DB9F, Suitable for Nellcor probe	 081	 130	
Single Adapter Cable: 90351-D/G,90465,90466,90467,90489,90651-07/08 ; 2nd Adapter Cable: 90351-D/G,90465,90466,90467,90489,90651-07/08;		S0035HY-L	Exi-Cable,8ft, Hypertronics 12p>Hypertronics 7J, Suitable for Novamatrix probe	 775	 326 Code:	
<b>AnKe Choice MMED6000D/D</b>	AnKe:553; Biolight;BaoZhong Cheersails:CSM-2000; WanDong Goldway:UT4000A UT4000C 4000B; Jumbor:JB9101/9105/9107; TianRong; QiLan:M-III; HongRunDa:EM-6; JERRY:PM2000; JoyceTracker : BMD-50; Mindray:PM9000; Richer :RC9000; ShenMai:KP-900; Spurt:CP-1200; SHIPAI: KMI-1000; ZhongHengSheng :KD580; ZhongYua: HD-2000		S0007BC-L	Exi-Cable, 8ft, Readell 1bt 5P>DB9F, Suitable for BCI probe	 074	

SpO<sub>2</sub> Sensor Extension Cable (China brand)



Compatible Brand	Compatible Models No.	OEM P/N	REF NO.	Description (Name,Length,Plug,Compatible)	INSTRUMENT CONNECTOR	CONNECTOR (SENSOR SIDE)
<b>Biolight</b>	M6,M12, M69(new version);		S0029BC-L	Exi-Cable,8ft, Readel 1bt 5P>DB9F, Suitable for BCI probe	408	
	BLT: M66, M69(Old version);		S0101BC-L	Exi-Cable,8ft, Lemo 1b 5P>DB9F, Suitable for BCI probe	044	
<b>Biocare Jumbor</b>	BM9000;		S0022BC-L	Exi-Cable,8ft, Readel 2bit.6P>DB9F, Suitable for BCI probe MOQ:50pcs	076	
<b>Choice oximax module</b>	NELLCOR OXIMAX module		S0112OX-L	Exi-Cable,8ft, Readel 1bt 9P>DB9F, Suitable for Nellcor probe DS-100A and MED-LINK S0026B-S	444	205
<b>Creative Contec</b>	<u>Creative</u> : PC9000,UP6000, <u>TOB-MED</u> : TOM MS-6-P, <u>EDAN</u> : M9, <u>BIOCARE</u> : BM9000, <u>Goldway</u> , <u>Contec</u> , <u>DHR930</u> ;		S0063BC-L	Exi-Cable,8ft, Readel 2bit.6P>DB9F, Suitable for BCI probe instead of S0047BC-L	076	
<b>Creative</b>	PC5000, PC9000.		S0160NE-L	Exi-Cable,8ft, Readel 2bit.6P>DB9F, Suitable for BCI probe instead of S0010BC-L	076	
<b>Contec</b>	CMS-7000		S0155NE-L	Exi-Cable,8ft, Readel 1bt 5P>DB9F, Suitable for BCI probe	408	
<b>GOLDWAY</b>			S0061BC-L	Exi-Cable,8ft, Readel 2bt 7P>DB9F, Suitable for BCI probe	041	
	Goldway: UT4000A, UT4000C 4000B PACE TECH;		S0007BC-L	Exi-Cable,8ft, Readel 1bit.5p>DB9F, Suitable for BCI probe	074	
	UT4000A, UT4000C, UT4000E, UT4000F, UT4000Apro, UT4000Fpro, UT6000A;		S0038BC-L	Exi-Cable,8ft, Lemo 1B.5>DB9F, Suitable for BCI probe	696	
<b>3F</b>	COMEN:STAR-1000; LANKE:LK-8600A; 3F : DIONA PMS-8100; CSI:RADO 4200; MAYTAG:MTK-2000;		S0021BC-L	Exi-Cable,8ft, Readel 1bt 6P>DB9F, Suitable for BCI probe	583	
<b>Neusoft</b>	NSC series patient monitor;		S0003OX-L	Exi-Cable,8ft, Round 12p>DB9F, Compatible for NELLCOR sensor and MED-LINK S0010B-S	128	205
<b>MMED6000DP /M10</b>	MMED6000DP/M10, KD580;		S0169NE-L	Exi-Cable,8ft, Readel 1bit.6P>DB9F, Suitable for BCI probe		130

One-Piece Series ECG Cable With Leads

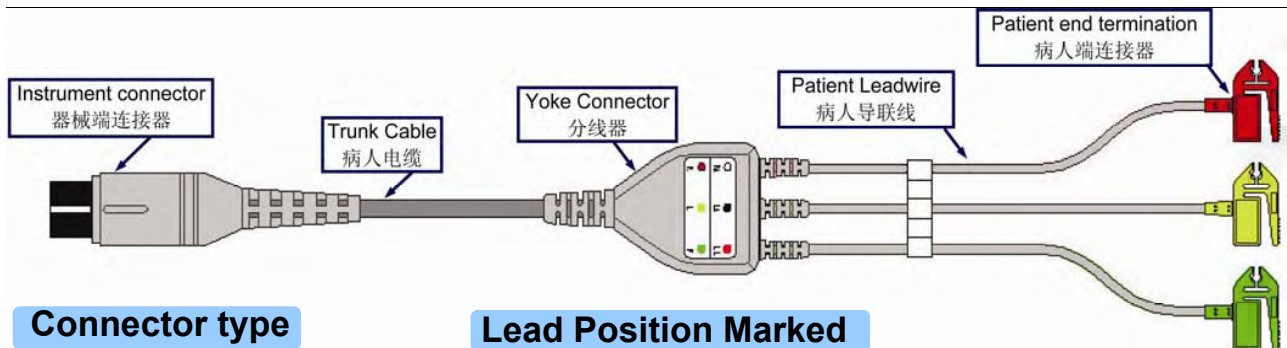

Connector type



Lead Position Marked

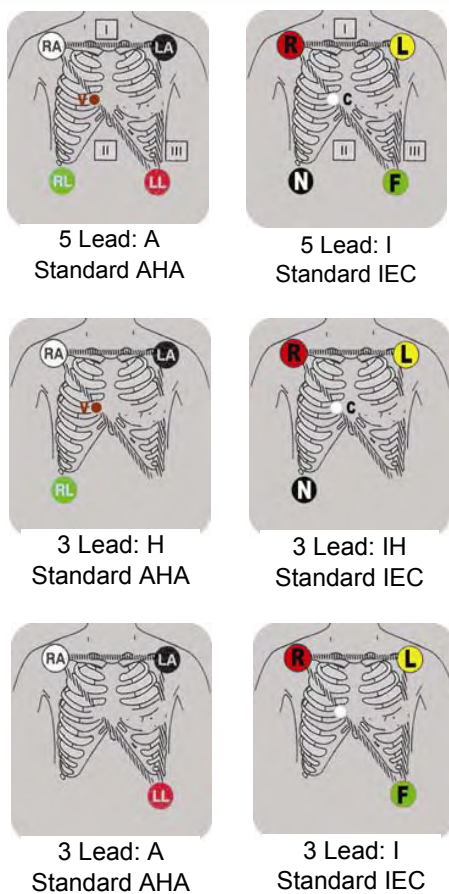

Standard Snap S

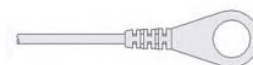

type AA Grabber A



type RL Grabber RL C



### One-Piece Series ECG Cable With Leads



Compatible Brand	Compatible Models No.	INSTRUMENT CONNECTOR	REF NO.	STANDARD	LEADS	PATIENT END TERMINAL	Material	
<b>BIONET KOREA</b>	BM3		EA041S5A	AHA,	5LD:A,	SNAP,	TPU,	1KΩ
			EA041S3A	AHA,	3LD:A,	SNAP,	TPU,	1KΩ
			EA041C3A	AHA,	3LD:A,	CLIP,	TPU,	1KΩ
			EA041C5I	IEC,	5LD:I,	CLIP,	TPU,	1KΩ
			EA041S3I	IEC,	3LD:I,	SNAP,	TPU,	1KΩ
<b>BIOSYS KOREA</b>	BPM-103		EA040S3A	AHA,	3LD:A,	SNAP,	TPU,	1KΩ
			EA040S5I	IEC,	5LD:I,	SNAP,	TPU,	1KΩ
			EA040S3I	IEC,	3LD:I,	SNAP,	TPU,	1KΩ
<b>BRUKER (ODAM)</b>	SM784, SM785 with 12-pin input connector		EA017C3IH	IEC,	3LD:IH,	CLIP,	TPU,	
<b>COLIN</b>	BP88 / BP306		EA062S5A	AHA,	5LD:A,	SNAP,	TPU,	
			EA062C5A	AHA,	5LD:A,	CLIP,	TPU,	
			EA062S3A	AHA,	3LD:A,	SNAP,	TPU,	
			EA062S5I	IEC,	5LD:I,	SNAP,	TPU,	
			EA062S3I	IEC,	3LD:I,	SNAP,	TPU,	
	BP88S		EA061S3A	AHA,	3LD:A,	SNAP,	TPU,	
			EA061S5I	IEC,	5LD:I,	SNAP,	TPU,	
			EA061C5I	IEC,	5LD:I,	CLIP,	TPU,	
			EA061S3I	IEC,	3LD:I,	SNAP,	TPU,	
			EA061C3I	IEC,	3LD:I,	CLIP,	TPU,	
<b>Creative Spurt Biolight</b>	Creative:PC9000S,PC9000,UP6000, Biolight: M12		EA046S5A	AHA,	5LD:A,	SNAP,	TPU,	
			EA046C5A	AHA,	5LD:A,	CLIP,	TPU,	
			EA046S3A	AHA,	3LD:A,	SNAP,	TPU,	
			EA046C3A	AHA,	3LD:A,	CLIP,	TPU,	
			EA046S5I	IEC,	5LD:I,	SNAP,	TPU,	
			EA046C5I	IEC,	5LD:I,	CLIP,	TPU,	
			EA046C3I	IEC,	3LD:I,	CLIP,	TPU,	
<b>Corpuls</b>	Corpuls 08/16, 0816M 		EA076C3IH	IEC,	4LD:IH,	CLIP,	TPU,	
<b>DATASCOPE</b>	2000,2001,2002,2100,2200,3000, 3000A ,Ballon Pump, M/D3 w/lead select,M/D3A,M/D4, Passport,Passport IL,Passport XG, Passport XL,Passport 2, Passport 2LT,Spectrum System 90, System 90T , System 96, System 97		EA002S5A	AHA,	5LD:A,	SNAP,	TPU,	
			EA002C5A	AHA,	5LD:A,	CLIP,	TPU,	6P
			EA002S3A	AHA,	3LD:A,	SNAP,	TPU,	
			EA002C3A	AHA,	3LD:A,	CLIP,	TPU,	
			EA002S5I	IEC,	5LD:I,	SNAP,	TPU,	
			EA002C5I	IEC,	5LD:I,	CLIP,	TPU,	
			EA002S3I	IEC,	3LD:I,	SNAP,	TPU,	
			EA002C3I	IEC,	3LD:I,	CLIP,	TPU,	













One-Piece Series ECG Cable With Leads

Compatible Brand	Compatible Models No.	INSTRUMENT CONNECTOR	REF NO.	STANDARD	LEADS	PATIENT END TERMINAL	Material																																																																																																																																																																																																																		
<b>DATEX</b>	AS/3, CS/3, S/5, Cardiocap 1, Cardiocap 2 , Cardiocap 5 , Light Monitor , Satliteplus		EA010S5A	AHA,	5LD:A,	SNAP,	TPU,																																																																																																																																																																																																																		
			EA010C5A	AHA,	5LD:A,	CLIP,	TPU,																																																																																																																																																																																																																		
			EA010S3A	AHA,	3LD:A,	SNAP,	TPU,																																																																																																																																																																																																																		
			EA010C3A	AHA,	3LD:A,	CLIP,	TPU,																																																																																																																																																																																																																		
			EA010S5I	IEC,	5LD:I,	SNAP,	TPU,																																																																																																																																																																																																																		
			EA010C5I	IEC,	5LD:I,	CLIP,	TPU,																																																																																																																																																																																																																		
			EA010S3I	IEC,	3LD:I,	SNAP,	TPU,																																																																																																																																																																																																																		
<b>DRAGER SIEMENS</b>	Drager UM1/3/3.1, RM1, PM8010, PM8014, Babyguard 8000, Cato, Babylog8000/8000 plus, PB8800 Serie 8000, Cicero, Parameterbox,		EA057C3I	IEC,	3LD:I,	CLIP,	TPU,						<b>FUKUDA DENSHI</b>	DATASCOPE:Expert FUKUDA DENSHI:DS5100E, DS5300W, DS5400,		EA068S3A	AHA,	3LD:A,	SNAP,	TPU, 1KΩ	EA068C3A	AHA,	3LD:A,	CLIP,	TPU, 1KΩ	EA068S5I	IEC,	5LD:I,	SNAP,	TPU, 1KΩ	EA068C5I	IEC,	5LD:I,	CLIP,	TPU, 1KΩ	EA068S3I	IEC,	3LD:I,	SNAP,	TPU, 1KΩ	<b>PETAS</b>			EA064S3H	AHA,	3LD:H,	SNAP,	TPU,	EA064C3H	AHA,	3LD:H,	CLIP,	TPU,	EA064S3IH	IEC,	3LD:IH,	SNAP,	TPU,	EA064C3IH	IEC,	3LD:IH,	CLIP,	TPU,	<b>GE-MEDICAL Marquette</b>	GEMS:Dash PRO 4000, Dash PRO 3000, Dash PRO 2000, Dash 1000, Eagle Systems, MAC-Lab, Solar 9500, Solar 8000. Solar 3000, Tram 100, Tram 200, Tram 300, Tram 400, Tram 500, Tram 600, Tram 800, Unity Systems		EA007S5A	AHA,	5LD:A,	SNAP,	TPU,	EA007C5A	AHA,	5LD:A,	CLIP,	TPU,	EA007S3A	AHA,	3LD:A,	SNAP,	TPU,	EA007C3A	AHA,	3LD:A,	CLIP,	TPU,	EA007S5I	IEC,	5LD:I,	SNAP,	TPU,	EA007C5I	IEC,	5LD:I,	CLIP,	TPU,	EA007S3I	IEC,	3LD:I,	SNAP,	TPU,	EA007C3I	IEC,	3LD:I,	CLIP,	TPU,	PRO1000		EA021S3A	AHA,	3LD:A,	SNAP,	TPU, 1KΩ	EA021S3I	IEC,	3LD:I,	SNAP,	TPU, 1KΩ	<b>GE-MEDICAL</b>	GE MEDICAL SYSTEMS:2000, 2020, 2110, 2110N, 2120, 2210, 2230, 2230N, 2310, 2330, 2330N, 7000 Series, Tram AR		EA069S5A	AHA,	5LD:A,	SNAP,	TPU,	EA069C5A	AHA,	5LD:A,	CLIP,	TPU,	EA069S3A	AHA,	3LD:A,	SNAP,	TPU,	EA069C3A	AHA,	3LD:A,	CLIP,	TPU,	EA069S5I	IEC,	5LD:I,	SNAP,	TPU,	EA069C5I	IEC,	5LD:I,	CLIP,	TPU,	EA069S3I	IEC,	3LD:I,	SNAP,	TPU,	EA069C3I	IEC,	3LD:I,	CLIP,	TPU,	<b>HELLIGE</b>	Hellige,Servomed 4 , Generation, SCP 851, SCP 852 , SCP 844, SCS 804,, CardioServ , VICOM-sm		EA011S5A	AHA,	5LD:A,	SNAP,	TPU,	EA011C5A	AHA,	5LD:A,	CLIP,	TPU,	EA011S3A	AHA,	3LD:A,	SNAP,	TPU,	EA011C3I	IEC,	3LD:I,	CLIP,	TPU,	<b>KONTRON</b>	7000, 7135, 7135B, 7141, 7210 7250, 7251, K2000, KAAAT, Kolormon, Micromon, Minimon, Supermon , Vitalmon		EA031S5A	AHA,	5LD:A,	SNAP,	TPU,	EA031C5A	AHA,	5LD:A,	CLIP,	TPU,	EA031S5I	IEC,	5LD:I,	SNAP,	TPU,	EA031C5I	IEC,	5LD:I,	CLIP,	TPU,	EA031S3I	IEC,	3LD:I,	SNAP,	TPU,	EA031C3I	IEC,	3LD:I,	CLIP,	TPU,
			<b>DRAGER SIEMENS</b>	Drager UM1/3/3.1, RM1, PM8010, PM8014, Babyguard 8000, Cato, Babylog8000/8000 plus, PB8800 Serie 8000, Cicero, Parameterbox,		EA057C3I	IEC,	3LD:I,	CLIP,	TPU,																																																																																																																																																																																																															
<b>FUKUDA DENSHI</b>	DATASCOPE:Expert FUKUDA DENSHI:DS5100E, DS5300W, DS5400,		EA068S3A	AHA,	3LD:A,	SNAP,	TPU, 1KΩ																																																																																																																																																																																																																		
			EA068C3A	AHA,	3LD:A,	CLIP,	TPU, 1KΩ																																																																																																																																																																																																																		
			EA068S5I	IEC,	5LD:I,	SNAP,	TPU, 1KΩ																																																																																																																																																																																																																		
			EA068C5I	IEC,	5LD:I,	CLIP,	TPU, 1KΩ																																																																																																																																																																																																																		
			EA068S3I	IEC,	3LD:I,	SNAP,	TPU, 1KΩ																																																																																																																																																																																																																		
<b>PETAS</b>			EA064S3H	AHA,	3LD:H,	SNAP,	TPU,	EA064C3H	AHA,	3LD:H,	CLIP,	TPU,	EA064S3IH	IEC,	3LD:IH,	SNAP,	TPU,	EA064C3IH	IEC,	3LD:IH,	CLIP,	TPU,	<b>GE-MEDICAL Marquette</b>	GEMS:Dash PRO 4000, Dash PRO 3000, Dash PRO 2000, Dash 1000, Eagle Systems, MAC-Lab, Solar 9500, Solar 8000. Solar 3000, Tram 100, Tram 200, Tram 300, Tram 400, Tram 500, Tram 600, Tram 800, Unity Systems		EA007S5A	AHA,	5LD:A,	SNAP,	TPU,	EA007C5A	AHA,	5LD:A,	CLIP,	TPU,	EA007S3A	AHA,	3LD:A,	SNAP,	TPU,	EA007C3A	AHA,	3LD:A,	CLIP,	TPU,	EA007S5I	IEC,	5LD:I,	SNAP,	TPU,	EA007C5I	IEC,	5LD:I,	CLIP,	TPU,	EA007S3I	IEC,	3LD:I,	SNAP,	TPU,	EA007C3I	IEC,	3LD:I,		CLIP,	TPU,	PRO1000		EA021S3A	AHA,	3LD:A,	SNAP,	TPU, 1KΩ	EA021S3I	IEC,	3LD:I,	SNAP,	TPU, 1KΩ	<b>GE-MEDICAL</b>	GE MEDICAL SYSTEMS:2000, 2020, 2110, 2110N, 2120, 2210, 2230, 2230N, 2310, 2330, 2330N, 7000 Series, Tram AR		EA069S5A	AHA,	5LD:A,	SNAP,	TPU,	EA069C5A	AHA,	5LD:A,	CLIP,	TPU,	EA069S3A	AHA,	3LD:A,	SNAP,	TPU,	EA069C3A	AHA,	3LD:A,	CLIP,	TPU,	EA069S5I	IEC,	5LD:I,	SNAP,	TPU,	EA069C5I	IEC,	5LD:I,	CLIP,	TPU,	EA069S3I	IEC,	3LD:I,	SNAP,	TPU,	EA069C3I	IEC,	3LD:I,	CLIP,	TPU,	<b>HELLIGE</b>	Hellige,Servomed 4 , Generation, SCP 851, SCP 852 , SCP 844, SCS 804,, CardioServ , VICOM-sm		EA011S5A	AHA,	5LD:A,	SNAP,	TPU,	EA011C5A	AHA,	5LD:A,	CLIP,	TPU,	EA011S3A	AHA,	3LD:A,	SNAP,	TPU,	EA011C3I	IEC,	3LD:I,	CLIP,	TPU,	<b>KONTRON</b>	7000, 7135, 7135B, 7141, 7210 7250, 7251, K2000, KAAAT, Kolormon, Micromon, Minimon, Supermon , Vitalmon		EA031S5A	AHA,	5LD:A,	SNAP,	TPU,	EA031C5A	AHA,	5LD:A,	CLIP,	TPU,	EA031S5I	IEC,	5LD:I,	SNAP,	TPU,	EA031C5I	IEC,	5LD:I,	CLIP,	TPU,	EA031S3I	IEC,	3LD:I,	SNAP,	TPU,	EA031C3I	IEC,	3LD:I,	CLIP,	TPU,																																								
			<b>PETAS</b>			EA064S3H	AHA,	3LD:H,	SNAP,	TPU,																																																																																																																																																																																																															
						EA064C3H	AHA,	3LD:H,	CLIP,	TPU,																																																																																																																																																																																																															
						EA064S3IH	IEC,	3LD:IH,	SNAP,	TPU,																																																																																																																																																																																																															
EA064C3IH	IEC,	3LD:IH,				CLIP,	TPU,																																																																																																																																																																																																																		
<b>GE-MEDICAL Marquette</b>	GEMS:Dash PRO 4000, Dash PRO 3000, Dash PRO 2000, Dash 1000, Eagle Systems, MAC-Lab, Solar 9500, Solar 8000. Solar 3000, Tram 100, Tram 200, Tram 300, Tram 400, Tram 500, Tram 600, Tram 800, Unity Systems		EA007S5A	AHA,	5LD:A,	SNAP,	TPU,																																																																																																																																																																																																																		
			EA007C5A	AHA,	5LD:A,	CLIP,	TPU,																																																																																																																																																																																																																		
			EA007S3A	AHA,	3LD:A,	SNAP,	TPU,																																																																																																																																																																																																																		
			EA007C3A	AHA,	3LD:A,	CLIP,	TPU,																																																																																																																																																																																																																		
			EA007S5I	IEC,	5LD:I,	SNAP,	TPU,																																																																																																																																																																																																																		
			EA007C5I	IEC,	5LD:I,	CLIP,	TPU,																																																																																																																																																																																																																		
			EA007S3I	IEC,	3LD:I,	SNAP,	TPU,																																																																																																																																																																																																																		
			EA007C3I	IEC,	3LD:I,	CLIP,	TPU,																																																																																																																																																																																																																		
	PRO1000		EA021S3A	AHA,	3LD:A,	SNAP,	TPU, 1KΩ																																																																																																																																																																																																																		
			EA021S3I	IEC,	3LD:I,	SNAP,	TPU, 1KΩ																																																																																																																																																																																																																		
<b>GE-MEDICAL</b>	GE MEDICAL SYSTEMS:2000, 2020, 2110, 2110N, 2120, 2210, 2230, 2230N, 2310, 2330, 2330N, 7000 Series, Tram AR		EA069S5A	AHA,	5LD:A,	SNAP,	TPU,	EA069C5A	AHA,	5LD:A,	CLIP,	TPU,	EA069S3A	AHA,	3LD:A,	SNAP,	TPU,	EA069C3A	AHA,	3LD:A,	CLIP,	TPU,	EA069S5I	IEC,	5LD:I,	SNAP,	TPU,	EA069C5I	IEC,	5LD:I,	CLIP,	TPU,	EA069S3I	IEC,	3LD:I,	SNAP,	TPU,	EA069C3I	IEC,	3LD:I,	CLIP,	TPU,	<b>HELLIGE</b>	Hellige,Servomed 4 , Generation, SCP 851, SCP 852 , SCP 844, SCS 804,, CardioServ , VICOM-sm		EA011S5A	AHA,	5LD:A,	SNAP,	TPU,	EA011C5A	AHA,	5LD:A,	CLIP,	TPU,	EA011S3A	AHA,	3LD:A,	SNAP,	TPU,	EA011C3I	IEC,	3LD:I,	CLIP,	TPU,	<b>KONTRON</b>	7000, 7135, 7135B, 7141, 7210 7250, 7251, K2000, KAAAT, Kolormon, Micromon, Minimon, Supermon , Vitalmon		EA031S5A	AHA,	5LD:A,	SNAP,	TPU,	EA031C5A	AHA,	5LD:A,	CLIP,	TPU,	EA031S5I	IEC,	5LD:I,	SNAP,	TPU,	EA031C5I	IEC,	5LD:I,	CLIP,	TPU,	EA031S3I	IEC,	3LD:I,	SNAP,	TPU,	EA031C3I	IEC,	3LD:I,	CLIP,	TPU,																																																																																																																							
			<b>GE-MEDICAL</b>	GE MEDICAL SYSTEMS:2000, 2020, 2110, 2110N, 2120, 2210, 2230, 2230N, 2310, 2330, 2330N, 7000 Series, Tram AR		EA069S5A	AHA,	5LD:A,	SNAP,	TPU,																																																																																																																																																																																																															
						EA069C5A	AHA,	5LD:A,	CLIP,	TPU,																																																																																																																																																																																																															
						EA069S3A	AHA,	3LD:A,	SNAP,	TPU,																																																																																																																																																																																																															
						EA069C3A	AHA,	3LD:A,	CLIP,	TPU,																																																																																																																																																																																																															
						EA069S5I	IEC,	5LD:I,	SNAP,	TPU,																																																																																																																																																																																																															
						EA069C5I	IEC,	5LD:I,	CLIP,	TPU,																																																																																																																																																																																																															
						EA069S3I	IEC,	3LD:I,	SNAP,	TPU,																																																																																																																																																																																																															
EA069C3I	IEC,	3LD:I,				CLIP,	TPU,																																																																																																																																																																																																																		
<b>HELLIGE</b>	Hellige,Servomed 4 , Generation, SCP 851, SCP 852 , SCP 844, SCS 804,, CardioServ , VICOM-sm		EA011S5A	AHA,	5LD:A,	SNAP,	TPU,																																																																																																																																																																																																																		
			EA011C5A	AHA,	5LD:A,	CLIP,	TPU,																																																																																																																																																																																																																		
			EA011S3A	AHA,	3LD:A,	SNAP,	TPU,																																																																																																																																																																																																																		
			EA011C3I	IEC,	3LD:I,	CLIP,	TPU,																																																																																																																																																																																																																		
<b>KONTRON</b>	7000, 7135, 7135B, 7141, 7210 7250, 7251, K2000, KAAAT, Kolormon, Micromon, Minimon, Supermon , Vitalmon		EA031S5A	AHA,	5LD:A,	SNAP,	TPU,																																																																																																																																																																																																																		
			EA031C5A	AHA,	5LD:A,	CLIP,	TPU,																																																																																																																																																																																																																		
			EA031S5I	IEC,	5LD:I,	SNAP,	TPU,																																																																																																																																																																																																																		
			EA031C5I	IEC,	5LD:I,	CLIP,	TPU,																																																																																																																																																																																																																		
			EA031S3I	IEC,	3LD:I,	SNAP,	TPU,																																																																																																																																																																																																																		
EA031C3I	IEC,	3LD:I,	CLIP,	TPU,																																																																																																																																																																																																																					

## One-Piece Series ECG Cable With Leads



Compatible Brand	Compatible Models No.	INSTRUMENT CONNECTOR	REF NO.	STANDARD	LEADS	PATIENT END TERMINAL	Material	
<b>KONTRON</b>			EA032C3A	AHA,	3LD:A,	CLIP,	TPU,	
			EA032S3I	IEC,	3LD:I,	SNAP,	TPU,	
			EA032C3I	IEC,	3LD:I,	CLIP,	TPU,	
<b>L&amp;T (INDIA )</b>	DLanet50		EA030S3H	AHA,	3LD:H,	SNAP,	TPU, 1KΩ	
			EA030C3H	AHA,	3LD:H,	CLIP,	TPU, 1KΩ	
			EA030S3IH	IEC,	3LD:IH,	SNAP,	TPU, 1KΩ	
			EA030C3IH	IEC,	3LD:IH,	CLIP,	TPU, 1KΩ	
	MP1000,MP600,MP500		EA029S3A	AHA,	3LD:A,	SNAP,	TPU,	
			EA029C3A	AHA,	3LD:A,	CLIP,	TPU,	
			EA029C5I	IEC,	5LD:I,	CLIP,	TPU,	
	M160246 M360697	172		EA029S3I	IEC,	3LD:I,	SNAP,	TPU,
				EA029C3I	IEC,	3LD:I,	CLIP,	TPU,
				EA033S3A	AHA,	3LD:A,	SNAP,	TPU,
<b>M&amp;B</b>			EA033C3A	AHA,	3LD:A,	CLIP,	TPU,	
			EA033C5I	IEC,	5LD:I,	CLIP,	TPU,	
			EA033C3I	IEC,	3LD:I,	CLIP,	TPU,	
			EA072S3A	AHA,	3LD:A,	SNAP,	TPU,	
<b>M&amp;B</b>			EA072S5A	AHA,	5LD:A,	SNAP,	TPU,	
<b>MENNEN</b>	Horizon 250,3000,450, Microsolo,936 Series,425/101 Preamp,Cardio-Pak 2000,740, 741,742	236		EA059S3A	AHA,	3LD:A,	SNAP,	TPU, 1KΩ
				EA059C3A	AHA,	3LD:A,	CLIP,	TPU, 1KΩ
				EA059S3I	IEC,	3LD:I,	SNAP,	TPU, 1KΩ
				EA059C3I	IEC,	3LD:I,	CLIP,	TPU, 1KΩ
	(MENNEN):900,1100,1110, Horizon 2000,2100,2200,5200 Horizon 9000XL,MR1200,1270 Horizon 1280,1300,Horizon 1380	175		EA065S3A	AHA,	3LD:A,	SNAP,	TPU,
				EA065C3A	AHA,	3LD:A,	CLIP,	TPU,
				EA065S5I	IEC,	5LD:I,	SNAP,	TPU,
				EA065C5I	IEC,	5LD:I,	CLIP,	TPU,
<b>MINDRAY</b>	PM7000/8000/9000		EA065C3I	IEC,	3LD:I,	CLIP,	TPU,	
			EA085S3A	AHA,	3LD:A,	SNAP,	TPU,	
			EA085C3A	AHA,	3LD:A,	CLIP,	TPU,	
			EA085S3I	IEC,	3LD:I,	SNAP,	TPU,	
			EA085C3I	IEC,	3LD:I,	CLIP,	TPU,	
			EA085S5A	AHA,	5LD:A,	SNAP,	TPU,	
			EA085C5A	AHA,	5LD:A,	CLIP,	TPU,	
			EA085S5I	IEC,	5LD:I,	SNAP,	TPU,	
MEC1000, MEC1200 with 6-pin input connector	004		EA085C5I	IEC,	5LD:I,	CLIP,	TPU,	
			EA020S3A	AHA,	3LD:A,	SNAP,	TPU,	
			EA020C3A	AHA,	3LD:A,	CLIP,	TPU,	
			EA020S3I	IEC,	3LD:I,	SNAP,	TPU,	
			EA020C3I	IEC,	3LD:I,	CLIP,	TPU,	
			EA020S5A	AHA,	5LD:A,	SNAP,	TPU,	
			EA020C5A	AHA,	5LD:A,	CLIP,	TPU,	
			EA020S5I	IEC,	5LD:I,	SNAP,	TPU,	
BeneView (T5, T6, T8) iPM series 0010-30-42719 0010-30-42720 PM5000/6000 (12)	577		EA020C5I	IEC,	5LD:I,	CLIP,	TPU,	
			EA050S5A	AHA,	5LD:A,	SNAP,	TPU,	
			EA050S3A	AHA,	3LD:A,	SNAP,	TPU,	
			EA050C3A	AHA,	3LD:A,	CLIP,	TPU,	
			EA050S5I	IEC,	5LD:I,	SNAP,	TPU,	
			EA050C5I	IEC,	5LD:I,	CLIP,	TPU,	
			EA050S3I	IEC,	3LD:I,	SNAP,	TPU,	
			EA060S5A	AHA,	5LD:A,	SNAP,	TPU,	
			EA060S3A	AHA,	3LD:A,	SNAP,	TPU,	
			EA060S5I	IEC,	5LD:I,	SNAP,	TPU,	
			EA060S3I	IEC,	3LD:I,	SNAP,	TPU,	
			EA060C3I	IEC,	3LD:I,	CLIP,	TPU,	









One-Piece Series ECG Cable With Leads

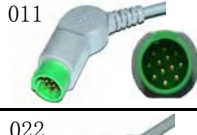

Compatible Brand	Compatible Models No.	INSTRUMENT CONNECTOR	REF NO.	STANDARD	LEADS	PATIENT END TERMINAL	Material
NEC	3M12		EA053S5A	AHA,	5LD:A,	SNAP,	TPU,
			EA053C5A	AHA,	5LD:A,	CLIP,	TPU,
			EA053S3A	AHA,	3LD:A,	SNAP,	TPU,
			EA053S3I	IEC,	3LD:I,	SNAP,	TPU,
PB1916E	026		EA054C3A	AHA,	3LD:A,	CLIP,	TPU,
			EA054S3I	IEC,	3LD:I,	SNAP,	TPU,
NIHON KOHDEN	OEC-6102A (s/n<20156), OEC-6105A (s/n<20226), OEC-6120A/J/K BSM-7105K	237	EA037S3I	IEC,	3LD:I,	SNAP,	TPU, 1KΩ
			EA037C3I	IEC,	3LD:I,	CLIP,	TPU, 1KΩ
	BSM-7102A,OMP-7201C, OMP-7203C, TEC-5200A (s/n<20421)	154	EA038S3I	IEC,	3LD:I,	SNAP,	TPU,
			EA038C3I	IEC,	3LD:I,	CLIP,	TPU,
TEC-7621C	491		EA075C3A	AHA,	3LD:A,	CLIP,	TPU, 200KΩ
TEC-7621K, TEC-7631C			EA074C3I	IEC,	3LD:I,	CLIP,	TPU, 100KΩ
PETAS	KMA160R,165R,260R,K-250,300...	014	EA063S3H	AHA,	3LD:H,	SNAP,	TPU,
			EA063C3H	AHA,	3LD:H,	CLIP,	TPU,
			EA063S3IH	IEC,	3LD:IH,	SNAP,	TPU,
			EA063C3IH	IEC,	3LD:IH,	CLIP,	TPU,
PHILIPS	43100A,43110A,43120A,78352C, 78354C,78834C,862474 C3, M1001A,M1002A,M1165A, M1166A,M1167A,M1175A,M1177A ,M1205A,M1264A,M1275A Transport, M1280A,M1722A/B,M1723A/B, M2475B,M2601A,M3000A,M3001A, M3046A M2/M3/M4,M4735A	018	EA023S5A	AHA,	5LD:A,	SNAP,	TPU, 1KΩ
			EA023C5A	AHA,	5LD:A,	CLIP,	TPU, 1KΩ
			EA023S3A	AHA,	3LD:A,	SNAP,	TPU, 1KΩ
			EA023C3A	AHA,	3LD:A,	CLIP,	TPU, 1KΩ
			EA023S5I	IEC,	5LD:I,	SNAP,	TPU, 1KΩ
			EA023C5I	IEC,	5LD:I,	CLIP,	TPU, 1KΩ
			EA023S3I	IEC,	3LD:I,	SNAP,	TPU, 1KΩ
			EA023C3I	IEC,	3LD:I,	CLIP,	TPU, 1KΩ
	43100A/43110A/43110M/43120A/MC Defib, 43200A Portable, M3500B,77000AC/77020A,77010AC Sonos/AC/AR,77025A,77030A,77035A ,77040A,78208A,78210A,78330A,7833 1A,78332A,78333A,78341A,78342A,78 345A,78346A,78351T,78352A/C,78353 A/B,78354A,78532A/B,78534A/B/C,78 619A,7	019	EA035S5A	AHA,	5LD:A,	SNAP,	TPU, 1KΩ
			EA035C5A	AHA,	5LD:A,	CLIP,	TPU, 1KΩ
			EA035S3A	AHA,	3LD:A,	SNAP,	TPU, 1KΩ
			EA035C3A	AHA,	3LD:A,	CLIP,	TPU, 1KΩ
			EA035S5I	IEC,	5LD:I,	SNAP,	TPU, 1KΩ
			EA035C5I	IEC,	5LD:I,	CLIP,	TPU, 1KΩ
EA035S3I	IEC,	3LD:I,	SNAP,	TPU, 1KΩ			
EA035C3I	IEC,	3LD:I,	CLIP,	TPU, 1KΩ			
Primedic		014	EA077S3H	AHA,	3LD:H,	SNAP,	TPU, 10KΩ
			EA077C3H	AHA,	3LD:H,	CLIP,	TPU, 10KΩ
			EA077S3IH	IEC,	3LD:IH,	SNAP,	TPU, 10KΩ
			EA077C3IH	IEC,	3LD:IH,	CLIP,	TPU, 10KΩ
MEDTRONIC PHYSIO- CONTROL	Lifepak 12 , 120, Lifepak 20	489	EA066S5A	AHA,	5LD:A,	SNAP,	TPU, 10KΩ
			EA066C5A	AHA,	5LD:A,	CLIP,	TPU, 10KΩ
			EA066S3A	AHA,	3LD:H,	SNAP,	TPU, 10KΩ
			EA066C3A	AHA,	3LD:H,	CLIP,	TPU, 10KΩ
			EA066S5I	IEC,	5LD:I,	SNAP,	TPU, 10KΩ
			EA066S3I	IEC,	3LD:IH,	SNAP,	TPU, 10KΩ
EA066C3I	IEC,	3LD:IH,	CLIP,	TPU, 10KΩ			

## One-Piece Series ECG Cable With Leads



Compatible Brand	Compatible Models No.	INSTRUMENT CONNECTOR	REF NO.	STANDARD	LEADS	PATIENT END TERMINAL	Material
<b>MEDTRONIC PHYSIO-CONTROL</b>	PHYSIO-CONTROL:Lifepak 2,3,33, Scope Monitor II; SIEMENS:Porta Pak 500PB, Porta Pak 500PM; SIMONSEN & WEELS(S&W):CB-600 Defib, DMS-600; SURVIVAL INSTRUMENTS:Safeguard I, II UNIRAD:Series C Echo,VIGGO-SPECTRAMED (Gould):Ekoline 20A, 21, Smith-Kline 20A		EA067S3A	AHA,	3LD:H,	SNAP,	TPU,
			EA067C3A	AHA,	3LD:H,	CLIP,	TPU,
			EA067S3I	IEC,	3LD:IH,	SNAP,	TPU,
			EA067C3I	IEC,	3LD:IH,	CLIP,	TPU,
<b>SAADAT</b>			EA083S3I	IEC,	3LD:IH,	SNAP,	TPU, 1KΩ
			EA083P3I	IEC,	3LD:IH,	SNAP,	TPU, 1KΩ
<b>S&amp;W (Artema) Diascope</b>	Diascope-NT, Athena Systems,		EA018S3A	AHA,	3LD:H,	SNAP,	TPU,
			EA018C5I	IEC,	5LD:I,	CLIP,	TPU,
			EA018S3I	IEC,	3LD:IH,	SNAP,	TPU,
			EA018C3I	IEC,	3LD:IH,	CLIP,	TPU,
<b>SIEMENS</b>	ECG Monitor, Polymed Modul,		EA052C5I	IEC,	5LD:I,	CLIP,	TPU,
<b>SCHILLER</b>	SHILLER ARGUS LCM+		EA082C5I	IEC,	5LD:I,	CLIP,	TPU, 1KΩ
<b>SPACELABS</b>	90496 Ultraview, 90369 Ultraview, 90367 Ultraview		EA009S5A	AHA,	5LD:A,	SNAP,	TPU, 1KΩ
			EA009C5A	AHA,	5LD:A,	CLIP,	TPU, 1KΩ
			EA009C3A	AHA,	3LD:A,	CLIP,	TPU, 1KΩ
			EA009S5I	IEC,	5LD:I,	SNAP,	TPU, 1KΩ
			EA009C5I3	IEC,	5LD:I,	CLIP,	TPU, 1KΩ
			EA009S3I	IEC,	3LD:I,	SNAP,	TPU, 1KΩ
			EA009C3I	IEC,	3LD:I,	CLIP,	TPU, 1KΩ
<b>SPACELABS BURDICK</b>	GE MEDICAL SYSTEMS:Corometrics 503,Corometrics 504,Corometrics 508; SIEMENS ELECTROMEDICAL SYSTEMS:806180A Nuclear Camera		EA036S3A	AHA,	3LD:H,	SNAP,	TPU,
			EA036C3A	AHA,	3LD:H,	CLIP,	TPU,
			EA036S3I	IEC,	3LD:IH,	SNAP,	TPU,
			EA036C3I	IEC,	3LD:IH,	CLIP,	TPU,
			<b>ADVANCED MEDICAL RESEARCH (AMR):Model 3R; AEQUITRON MEDICAL:9101,9216 (Neonate),ATL ULTRASOUND:Ultramark 8,Ultramark 6,Mark VIII,Mark III,Mark II,600,400; BARD:500,500 GILSON; BECKMAN (Offner):Offner Dynograph (all),VSM-10C,RM-10 BIOCROM; INC:All models; B</b>				
<b>WELCH ALLYN</b>	Propaq 100 Series, Propaq CS , Ultra Smart , Atlas Propaq 200 Series, Propaq Encore,		EA021S5A	AHA,	5LD:A,	SNAP,	TPU, 1KΩ
			EA021S3A	AHA,	3LD:A,	SNAP,	TPU, 1KΩ
			EA021S5I	IEC,	5LD:I,	SNAP,	TPU, 1KΩ
			EA021C5I	IEC,	5LD:I,	CLIP,	TPU, 1KΩ
			EA021S3I	IEC,	3LD:I,	SNAP,	TPU, 1KΩ
			EA021C3I	IEC,	3LD:I,	CLIP,	TPU, 1KΩ



ECG Trunk Cable and Leads for Patient monitor

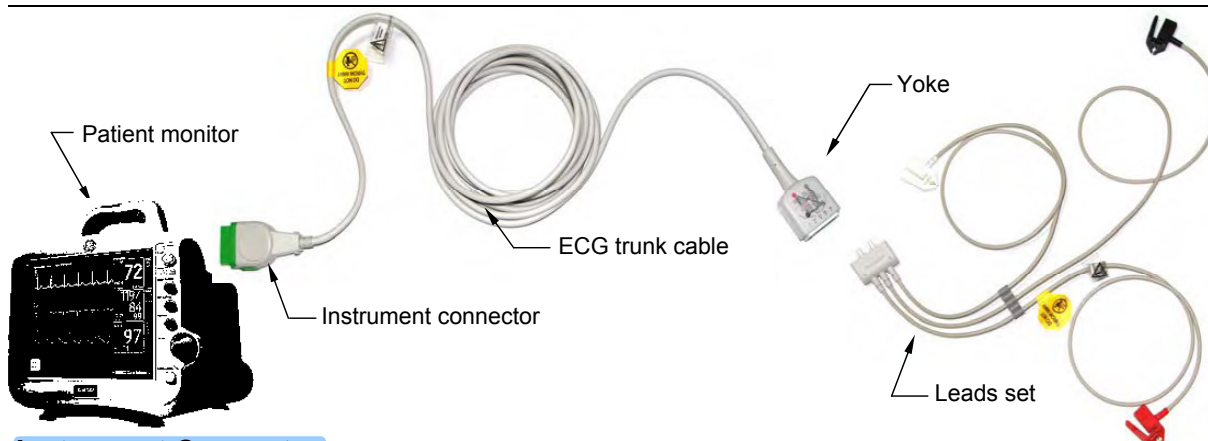

**Instrument Connector**

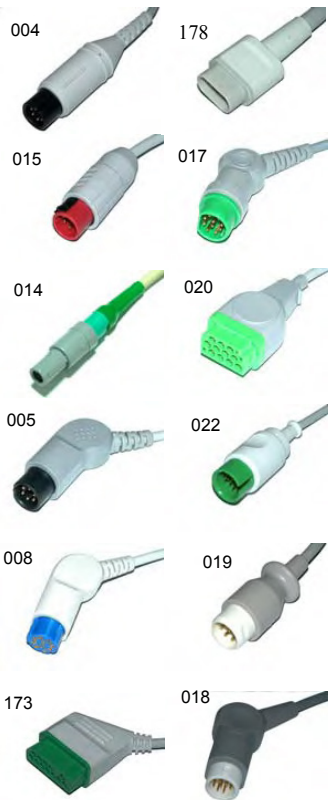

























**Yoke type and code**

Din 3-Ld, Code: <b>C</b>	Din 5-Ld, Code: <b>C</b>	Colin, 5-Ld, Code: <b>M</b>
Lifelinc(LL), 3-Ld, Code: <b>B</b>	Lifelinc(LL), 5-Ld, Code: <b>B</b>	TRU-link, 5-Ld, Code: <b>L</b>
ASP, 3-Ld, Code: <b>H</b>	ASP, 5-Ld, Code: <b>H</b>	VS, 5-Ld, Code: <b>E</b>
AAMI(AA), 3-Ld, Code: <b>D</b>	AAMI(AA), 5-Ld, Code: <b>D</b>	NK, 5-Ld, Code: <b>N</b>
EURO, 3-Ld, Code: <b>J</b>	EURO, 5-Ld, Code: <b>J</b>	NK, 6-Ld, Code: <b>P</b>
Conmed, 3-Ld, Code: <b>G</b>	Conmed, 5-Ld, Code: <b>G</b>	Multi-Link, 5Ld, Code: <b>Q</b>
NEC, 3-Ld, Code: <b>K</b>	NEC, 5-Ld, Code: <b>K</b>	Lohmeier multi-link, Code: <b>JM</b>
Multi-link, Code: <b>R</b>	Fukuda 16p, Code: <b>Y</b>	Philips M1668A yoke, Code: <b>DG</b>

Din2.0 Pin: **S**; 2.0Jack yoke: **T**; LL1 type yoke: **U**; NK Din2.0 jack: **V**  
 GE SEER 10Ld: **W**; GE MAX-1: **F**; Philips Trim Yoke: **X**;















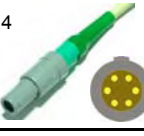
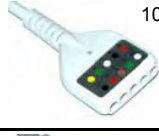





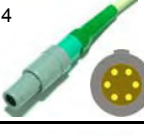

## ECG Trunk Cable and Leads for Patient monitor

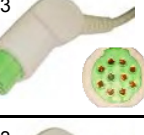

Compatible Brand	Compatible Models No.	OEM P/N	REF NO.	Description (Name,Length,Plug,Compatible)	INSTRUMENT CONNECTOR	Yoke (Leads side)
<b>Din Style Normal</b>	AIR SHIELDS (NARCO, Vickers):HRRM-71-1/2 ,Porta-Fib I, II, III,System 5 (new),System 6 (Neonatal); ATL ULTRASOUND:800 ,800 Plus,Apogee , CX ATL ULTRASOUND: CX200,CX400,HDI 9/2000,Interspec;	D-1340	EC020-3AI	Din 3Ld Patient Cable,9ft AHA/IEC, straight 6pin>Din 3J, no resistance fit for Din style LeadWires	004 	101 
		D-1540	EC020-5AI	Din 5Ld Patient Cable,9ft AHA/IEC, straight 6pin>Din 5J, no resistance fit for Din style LeadWires	004 	102 
			EC021-3AI	Din 3Ld Patient Cable,9ft AHA/IEC, straight 6pin>Din 3J, <b>1KΩ</b> resistance fit for Din style LeadWires	003 	101 
			EC021-5AI	Din 5Ld Patient Cable,9ft AHA/IEC, straight 6pin>Din 5J, <b>1KΩ</b> resistance fit for Din style LeadWires	003 	102 
<b>Lifelinc (LL) Style Normal</b>	LIFE SCIENCE INSTRUMENTS (LSI):LS5 , 261 MEDICAL DATA electronics (MDE):Escort 100, Escort 101, Escort 102 , Escort 200,Escort 300, Prism , 360SL, 450SL, 521A , PortaPak 80 , PortaPak 90 , PortaPak 1000;	EB020-3AI	LL 3Ld Patient Cable,9ft AHA/IEC, straight 6pin>LL 3LD, no resistance fit for LL style LeadWires	004 	107 	
		EB020-5AI	LL 5Ld Patient Cable,9ft AHA/IEC, straight 6pin>LL 5LD, no resistance fit for LL style LeadWires	004 	105 	
		EB021-3AI	LL 3Ld Patient Cable,9ft AHA/IEC, straight 6pin>LL 3LD, <b>1KΩ</b> resistance fit for LL style LeadWires	003 	107 	
		EB021-5AI	LL 5Ld Patient Cable,9ft AHA/IEC, straight 6pin>LL 5LD, <b>1KΩ</b> resistance , fit for LL style LeadWires	003 	105 	
<b>Conmed Style Normal</b>	PHILIPS MEDICAL SYSTEMS: M3921A A1 Compact Monitor , M3923A A1 Compact Monitor, M3925A A1 Compact Monitor , M3927A A3 Compact Monitor , M3929A A3 Compact Monitor PIONEER (American Optical): 26125 , 33167, 5260 , 5330 , Pulsar 4;	EG020-3AI	Conmed 3Ld Patient Cable, Length: 9ft ; AHA/IEC, straight 6pin>Conmed 3LD, no resistance, fit for Conmed style LeadWires	004 	671 	
		EG020-5AI	Conmed 5Ld Patient Cable, Length: 9ft ; AHA/IEC, straight 6pin>Conmed 5LD, no resistance, fit for Conmed style LeadWires	004 	672 	
		EG021-3AI	Conmed 3Ld Patient Cable, Length: 9ft ; AHA/IEC, straight 6pin>Conmed 3LD, <b>1KΩ</b> resistance, fit for Conmed style LeadWires	003 	671 	
		EG021-5AI	Conmed 5Ld Patient Cable, Length: 9ft ; AHA/IEC, straight 6pin>Conmed 5LD, <b>1KΩ</b> resistance, fit for Conmed style LeadWires	003 	672 	

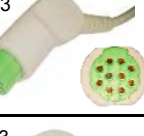
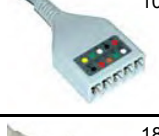
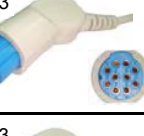

























ECG Trunk Cable and Leads for Patient monitor



Compatible Brand	Compatible Models No.	OEM P/N	REF NO.	Description (Name,Length,Plug,Compatible)	INSTRUMENT CONNECTOR	Yoke (Leads side)
<b>Bionet Korea</b>	BM3;		EB041-3AI	3Ld Patient Cable,9ft AHA/IEC, Round 8pin>LL-3LD, 1KΩ resistance fit for LL style LeadWires	 500	 107
<b>Biosys Korea</b>	BPM-103;		EC040-3AI	3Ld Patient Cable,9ft AHA/IEC, Readel 6pin>Din 3J, 1KΩ resistance fit for Din style LeadWires	 014	 101
			EC040-5AI	5Ld Patient Cable,9ft AHA/IEC, Readel 6pin>Din 5J, 1KΩ resistance fit for Din style LeadWires	 014	 102
<b>Colin</b>	BP88 / BP306;		EM062-5I	5Ld Patient Cable,9ft IEC, L type round 6pin>6J, no resistance fit for Colin LeadWires	 013	 083
	BP88S;		EM061-5I	5Ld Patient Cable,9ft IEC, straight 6P>6J, no resistance fit for Colin LeadWires	 025	 083
<b>Creative Spurt Biolight</b>	Creative: PC9000S,PC9000,UP6000, Biolight: M12 ;		EC046-3AI	3Ld Patient Cable,9ft AHA/IEC, Readel 6pin>Din 3J, 1KΩ resistance fit for Din style LeadWires	 014	 101
			EC046-5AI	5Ld Patient Cable,9ft AHA/IEC, Readel 6pin>Din 5J, 1KΩ resistance fit for Din style LeadWires	 014	 102
<b>Datascope</b>	2000,2001,2002,2100,2200,3000,3000A ,Ballon Pump,M/D3 w/lead select,M/D3A,M/D4,Passport, Passport IL,Passport XG,Passport XL,Passport 2,Passport 2LT,Spectrum System 90, System 90T , System 96, System 97;		EC002-3AI	Din 3Ld Patient Cable,9ft AHA/IEC, straight 6pin>Din 3J, no resistance fit for Din style LeadWires	 005	 101
			EC002-5AI	Din 5Ld Patient Cable,9ft AHA/IEC, straight 6pin>Din 5J, no resistance fit for Din style LeadWires	 005	 102
<b>Datex</b>	AS/3, CS/3, S/5, Cardiocap 1, Cardiocap 2 , Cardiocap 5 , Light Monitor , Satliteplus ;		EB010-3AI	3Ld Patient Cable,9ft AHA/IEC, Round 10J>LL 3LD, no resistance fit for LL style LeadWires	 023	 107
			EB010-5AI	5Ld Patient Cable,9ft AHA/IEC, Round 10J>LL 5LD, no resistance fit for LL style LeadWires	 023	 105
	Datex-Ohmeda Patient monitor;		EH010-3AI	3Ld Patient Cable,9ft AHA/IEC, Round 10J>ASP 3LD, 4.7KΩ resistance fit for ASP style LeadWires	 023	 183
	Datex-Ohmeda Patient monitor;		EH010-5AI	5Ld Patient Cable,9ft AHA/IEC, Round 10J>ASP 5LD, 4.7KΩ resistance fit for ASP style LeadWires	 023	 221

## ECG Trunk Cable and Leads for Patient monitor













Compatible Brand	Compatible Models No.	OEM P/N	REF NO.	Description (Name,Length,Plug,Compatible)	INSTRUMENT CONNECTOR	Yoke (Leads side)
NEC	3M12;	47524	EK053-3I	3Ld Patient Cable,9ft AHA/IEC, Round 16p>NEC 3LD, no resistance fit for 47504 LeadWires		 096
		47525	EK053-5I	5Ld Patient Cable,9ft AHA/IEC, Round 16p>NEC 5LD, no resistance fit for 47505 LeadWires		 099
Nihon Kohden	OEC-6102A (s/n<20156), OEC-6105A (s/n<20226), OEC-6120A/J/K BSM-7105K;		EC037-3AI	3Ld Patient Cable,9ft AHA/IEC, Round 8p>Din 3LD, no resistance fit for Din style LeadWires		 101
		JC-005P	EN037-3I	3Ld Patient Cable,9ft IEC, Round 8p>NK 6J, no resistance fit for BR-019 LeadWires		 155
Nihon Kohden	BSM-7102A,OMP-7201C, OMP-7203C, TEC-5200A (s/n<20421);		EC038-3AI	3Ld Patient Cable,9ft AHA/IEC, Round 11p>Din 3LD, no resistance fit for Din style LeadWires		 101
			EN038-3I	3Ld Patient Cable,9ft IEC, Round 11p>NK 6J no resistance fit for BR-019 LeadWires		 155
	BSM-2301, BSM-2353, BSM-5100, Multi-parameter bedside monitors BSM-73;	JC-906P	EP055-6I	6Ld Patient Cable,9ft ,IEC, Rectangle 12p>NK 8J, no resistance fit for BR-903P, BR-906P		 174
	OPV-1500 Lifescope N BSM-73;	L060 JC-103T	EP080-3I	3Ld Patient Cable,9ft ,IEC, Rectangle 12p>NK 8J, no resistance fit for BR-903P, BR-906P		 174
PHILIPS	78352C,7834C, 78834C, M1001A/B, M1002A/B, M1722A/B, M1723A/B, M2475B, M3000A, M3001A, M4735A, VM4/V24;	M1500A	ED023-3A	3Ld Patient Cable,9ft AHA, Round 12p>AA-3LD 1KΩ resistance fit for AA style LeadWires		 086
		M1510A	ED023-3I	3Ld Patient Cable,9ft IEC, Round 12p>AA-3LD 1KΩ resistance fit for AA style LeadWires		 086
	78352C,7834C, 78834C, M1001A/B, M1002A/B, M1722A/B, M1723A/B, M2475B, M3000A, M3001A, M4735A, VM4/V24;	M1520A	ED023-5A	5Ld Patient Cable,9ft AHA, Round 12p>AA-5LD 1KΩ resistance fit for AA style LeadWires		 085
		M1530A	ED023-5I	5Ld Patient Cable,9ft IEC, Round 12p>AA-5LD 1KΩ resistance fit for AA style LeadWires		 085
PHILIPS	M3000A, M3001A, M1001A/B,M1002A/B, 78352C,78354C;	M1669A	EDG073-3AI	3Ld Patient Cable,9ft IEC/AAMI, Round 12p>3-LD 1KΩ resistance fit for Philips LeadWires		 519



ECG Trunk Cable and Leads for Patient monitor









LEAD WIRES

Low profile, insert molded snap or pinch connectors offer patient comfort and secure attachment to snap electrodes. The snap termination's ergonomic, teardrop design reduces tangling at the patient end connector. Grabber and mini clip terminations have du

Compatible Brand	Productor Guide	OEM P/N	REF NO.	Description (Name,Length,Leads,)	Color coding / Leads	Patient end termination
<b>Bionet</b> <b>Datex</b> <b>Siemens</b> <b>GE-Hellige</b> <b>Kontron</b> <b>Goldway</b> <b>S&amp;W (Artema)</b>  <p>135</p>	suitable for all LL-Plug System , Yoke type: Lifelinc(LL),,Code: <b>E</b>  <p>EB040C3A</p>  <p>EB040C5A</p>		EB024S3A	LL lead wires,	AHA (AAMI)	Snap
			EB024C3I	24 in. (61 cm) , 3-Ld	IEC	Grabber (Clip)
			EB024S5A	LL lead wires,	AHA (AAMI)	Snap
			EB024C5A	24 in. (61 cm) , 5-Ld	AHA (AAMI)	Grabber (Clip)
			EB040S3A	LL lead wires,	AHA (AAMI)	Snap
			EB040C3A	40 in. (102 cm) , 3-Ld	AHA (AAMI)	Grabber (Clip)
			EB040S3I	IEC	IEC	Snap
			EB040C3I	IEC	IEC	Grabber (Clip)
			EB040S5A	LL lead wires,	AHA (AAMI)	Snap
			EB040C5A	40 in. (102 cm) , 5-Ld	AHA (AAMI)	Grabber (Clip)
			EB040S5I	IEC	IEC	Snap
			EB040C5I	IEC	IEC	Grabber (Clip)
		<b>Biosys</b> <b>Creative</b> <b>Datascope</b> <b>Nihon Kohden</b> <b>AIR SHIELDS (NARCO, Vickers)</b> <b>ATL</b> <b>ULTRASOUND</b>  <p>141</p>	suitable for all Din-Plug System , Yoke type: Din style,Code: <b>C</b>  <p>EC040S3A</p>  <p>EC040S5A</p>		EC018S3A	Din lead wires,
	EC018S3I			18 in. (45 cm) , 3-Ld	IEC	Snap
	EC018S5A			Din lead wires,	AHA (AAMI)	Snap
	EC018C5A			18 in. (45 cm) , 5-Ld	AHA (AAMI)	Grabber (Clip)
	EC018C5I			IEC	IEC	Grabber (Clip)
	EC024S3A			Din lead wires,	AHA (AAMI)	Snap
	EC024C3I			24 in. (61 cm) , 3-Ld	IEC	Grabber (Clip)
	EC024S5A			Din lead wires,	AHA (AAMI)	Snap
	EC024C5A			24 in. (61 cm) , 5-Ld	AHA (AAMI)	Grabber (Clip)
	EC024S5I			IEC	IEC	Snap
	EC024C5I			IEC	IEC	Grabber (Clip)
	EC040S3A			Din lead wires,	AHA (AAMI)	Snap
	EC040C3A			40 in. (102 cm) , 3-Ld	AHA (AAMI)	Grabber (Clip)
	EC040S3I			IEC	IEC	Snap
	EC040C3I			IEC	IEC	Grabber (Clip)
	EC040S5A	Din lead wires,	AHA (AAMI)	Snap		
	EC040C5A	40 in. (102 cm) , 5-Ld	AHA (AAMI)	Grabber (Clip)		
	EC040S5I	IEC	IEC	Snap		
	EC040C5I	IEC	IEC	Grabber (Clip)		
<b>PHILIPS</b> M3000A, M3001A, M1001A/B, M1002A/B, 78352C, 78354C	 	M1673A	EDG040S3A	Multi-Link Ldwr, 3-Ld	AHA (AAMI)	Snap
		M1674A	EDG040S3I	Set-Group, 40 in (102cm)	IEC	Snap
		M1671A	EDG040C3A	IEC	AHA (AAMI)	Grabber (Clip)
		M1672A	EDG040C3I	IEC	IEC	Grabber (Clip)
		M1644A	EDG040S5A	Multi-Link Ldwr, 5-Ld	AHA (AAMI)	Snap
		M1645A	EDG040S5I	Set-Group,	IEC	Snap
		M1968A	EDG040C5A	LA,RA,V=40in(102cm);	AHA (AAMI)	Grabber (Clip)
		M1971A	EDG040C5I	LL,RL=61in(155cm);	IEC	Grabber (Clip)
<b>PHILIPS</b>  <p>139</p>	suitable for all AA-Plug System , Yoke type: AA style,Code: <b>D</b>  <p>ED040C5A</p>	M1605A	ED040S3A	AA lead wires,	AHA (AAMI)	Snap
		M1603A	ED040C3A	40 in. (102 cm) , 3-Ld	AHA (AAMI)	Grabber (Clip)
		M1615A	ED040S3I	IEC	IEC	Snap
		M1613A	ED040C3I	IEC	IEC	Grabber (Clip)
		M1625A	ED040S5A	AA lead wires, 5-Ld	AHA (AAMI)	Snap
		M1623A	ED040C5A	LA,RA,V 40in(102cm);	AHA (AAMI)	Grabber (Clip)
		M1635A	ED040S5I	LL,RL 61in(155cm)	IEC	Snap
		M1633A	ED040C5I	IEC	IEC	Grabber (Clip)
		M1601A	ED040C3A-OR	AA lead wires, OR	AHA (AAMI)	Grabber (Clip)
		M1611A	ED040C3I-OR	40 in. (102 cm) , 3-Ld	IEC	Grabber (Clip)
		M1621A	ED040C5A-OR	AA lead wires, 5-Ld , OR	AHA (AAMI)	Grabber (Clip)
		M1631A	ED040C5I-OR	LA,RA,V 40in(102cm); LL,RL 61in(155cm)	IEC	Grabber (Clip)











## ECG Trunk Cable and Leads for Patient monitor



Compatible Brand	Product Guide	OEM P/N	REF NO.	Description (Name,Length,Leads,)	Color coding / Leads	Patient end termination		
<b>GE--Marquette (Set –Group type Lead wires)</b>  185	suitable for all Multi-link(VS)-Plug System , Yoke type: Multi-link(VS),Code: <b>E</b>  EE029C3A	E9008LF	EE029S3A-G	Multi-Link Ldwr Set – <b>29 in.</b> Group,, <b>(76 cm) , 3-Ld</b>	AHA (AAMI)	Snap		
		E9003CL	EE029C3A-G		AHA (AAMI)	Grabber (Clip)		
		E9003CN	EE029C3I-G		IEC	Grabber (Clip)		
				E9008LG	EE051S3A-G	Multi-Link Ldwr Set – <b>51 in.</b> Group,, <b>(130 cm) , 3-Ld</b>	AHA (AAMI)	Snap
				E9003CM	EE051C3A-G		AHA (AAMI)	Grabber (Clip)
				E9003CP	EE051C3I-G		IEC	Grabber (Clip)
<b>GE--Marquette (Set –Group type Lead wires)</b> 	suitable for all Multi-link(VS)-Plug System , Yoke type: Multi-link(VS),Code: E  EE029S5A	E9008L	EE029S5A-G	Multi-Link Ldwr Set – <b>29 in.</b> Group,, <b>(76 cm) , 5-Ld</b>	AHA (AAMI)	Snap		
		E9003CE	EE029C5A-G		AHA (AAMI)	Grabber (Clip)		
		E9008LB	EE029S5I-G		IEC	Snap		
		E9003CG	EE029C5I-G		IEC	Grabber (Clip)		
				E9003CF	EE051C5A-G	Multi-Link Ldwr Set – <b>51 in.</b> Group,, <b>(130 cm) , 5-Ld</b>	AHA (AAMI)	Grabber (Clip)
					EE051C5I-G		IEC	Grabber (Clip)
				E9008LD	EE051S5A-GM	Multi-Link Ldwr SetGroup, <b>5-Ld , Mixed Length,</b> <i>RL,LL,V-51in.(130cm) ;</i> <i>RA,LA-29 in.(74cm)</i>	AHA (AAMI)	Snap
				E9003CJ	EE051C5A-GM		AHA (AAMI)	Grabber (Clip)
					EE051C5I-GM		IEC	Grabber (Clip)
<b>GE-Medical Marquette (Set –Assembly type Lead wires)</b>  140	suitable for all Multi-link(VS)-Plug System , Yoke type: Multi-link(VS),Code: E  EE051C5A-M	E9008KB	EE029S5A	Multi-Link Ldwr Set <b>29 in. (76 cm) , 5-Ld</b>	AHA (AAMI)	Snap		
		E9002ZW	EE029C5A		AHA (AAMI)	Grabber (Clip)		
		E9008KD	EE029S5I		IEC	Snap		
		E9002ZZ	EE029C5I		IEC	Grabber (Clip)		
				E9008KC	EE051S5A	Multi-Link Ldwr Set, <b>51 in. (130 cm) , 5-Ld</b>	AHA (AAMI)	Snap
				E9002ZY	EE051C5A		AHA (AAMI)	Grabber (Clip)
				E9008KE	EE051S5I	Multi-Link Ldwr Set, <b>5-Ld , Mixed Length,</b> <i>N,F,C-51in.(130cm) ;</i> <i>R,L-29 in.(74cm)</i>	IEC	Snap
				E9003A	EE051C5I		IEC	Grabber (Clip)
				E9008KF	EE051S5A-M		AHA (AAMI)	Snap
				E9003AA	EE051C5A-M		AHA (AAMI)	Grabber (Clip)
					EE051S5I-M		IEC	Snap
	E9003AB	EE051C5I-M	IEC	Grabber (Clip)				
<b>Datex PHILIPS PIONEER PPG SPACELABS BURDICK TEKTRONIX (Vitatek) WELCH ALLYN</b>  138	suitable for all Conmed-Plug System , Yoke type: Conmed,Code: <b>G</b>  EG040S5A		EG024C3I	Conmed lead wires, <b>24 in. (61 cm) , 3-Ld</b>	IEC	Grabber (Clip)		
			EG024S5A		AHA (AAMI)	Snap		
			EG024C5A	Conmed lead wires, <b>24 in. (61 cm) , 5-Ld</b>	AHA (AAMI)	Grabber (Clip)		
			EG024C5I		IEC	Grabber (Clip)		
					EG040S3A	Conmed lead wires, <b>40 in. (102 cm) , 3-Ld</b>	AHA (AAMI)	Snap
					EG040C3A		AHA (AAMI)	Grabber (Clip)
					EG040S3I		IEC	Snap
					EG040C3I		IEC	Grabber (Clip)
					EG040S5A			AHA (AAMI)
					EG040C5A	Conmed lead wires, <b>40 in. (102 cm) , 5-Ld</b>	AHA (AAMI)	Grabber (Clip)
					EG040S5I		IEC	Snap
	EG040C5I			IEC	Grabber (Clip)			

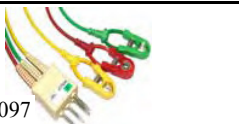

ECG Trunk Cable and Leads for Patient monitor

Compatible Brand	Productor Guide	OEM P/N	REF NO.	Description (Name,Length,Leads,)	Color coding / Leads	Patient end termination		
<b>Datex-Ohmeda GE-medical Pro1000</b>    137	suitable for all ASP-Plug System , Yoke type: ASP, Code: <u>H</u>    EH024C3I		EH024S3A	ASP lead wires, <u>24 in. (61 cm) , 3-Ld</u>	AHA (AAMI)	Snap		
			EH024C3I		IEC	Grabber (Clip)		
			EH024C5I	ASP lead wires, <u>24 in. (61 cm) , 5-Ld</u>	IEC	Grabber (Clip)		
			EH040S3A		AHA (AAMI)	Snap		
			EH040C3A	ASP lead wires, <u>40 in. (102 cm) , 3-Ld</u>	AHA (AAMI)	Grabber (Clip)		
			EH040S3I		IEC	Snap		
			EH040C3I		IEC	Grabber (Clip)		
			EH040S5A		AHA (AAMI)	Snap		
			EH040C5A	ASP lead wires, <u>40 in. (102 cm) , 5-Ld</u>	AHA (AAMI)	Grabber (Clip)		
			EH040S5I		IEC	Snap		
			EH040C5I		IEC	Grabber (Clip)		
		<b>type LM Lead wires</b>  494  	  		EZ040S3A		AHA (AAMI)	Snap
	EZ040C3A				AHA (AAMI)	Grabber (Clip)		
	EZ040S3I			LM lead wires, <u>40 in. (102 cm) , 3-Ld</u>	IEC	Snap		
	EZ040C3I				IEC	Grabber (Clip)		
	EZ040S5A				AHA (AAMI)	Snap		
	EZ040C5A			LM lead wires, <u>40 in. (102 cm) , 5-Ld</u>	AHA (AAMI)	Grabber (Clip)		
	EZ040S5I				IEC	Snap		
	EZ040C5I				IEC	Grabber (Clip)		
<b>Mindray Siemens SPACELABS BURDICK Viggo-Spectramed (Statham) WESTINGHOUSE</b>    084	suitable for all Euro-Plug System , Yoke type: Euro style, Code: <u>J</u>   EJ040S3I   EJ040S5I				EJ024C3I	Euro style lead wires, <u>24 in. (61 cm) , 3-Ld</u>	IEC	Grabber (Clip)
					EJ024C5A	Euro style lead wires, <u>24 in. (61 cm) , 5-Ld</u>	AHA (AAMI)	Grabber (Clip)
			EJ024C5I		IEC	Grabber (Clip)		
			EJ040S3A		AHA (AAMI)	Snap		
			EJ040C3A		AHA (AAMI)	Grabber (Clip)		
			EJ040M3A	Euro style lead wires, <u>40 in. (102 cm) , 3-Ld</u>	AHA (AAMI)	Mini Grabber (Clip)		
			EJ040S3I		IEC	Snap		
			EJ040C3I		IEC	Grabber (Clip)		
			EJ040S5A		AHA (AAMI)	Snap		
			EJ040C5A	Euro style lead wires, <u>40 in. (102 cm) , 5-Ld</u>	AHA (AAMI)	Grabber (Clip)		
			EJ040S5I		IEC	Snap		
			EJ040C5I		IEC	Grabber (Clip)		
		<b>NEC</b> suitable for all NEC-Plug System , Yoke type: NEC style, Code: K  097   100	  		EK029S3I	47504 style lead wires, <u>29 in. (76 cm) , 3-Ld</u>	IEC	Snap
	EK029S5I			47505 style lead wires, <u>29 in. (76 cm) , 5-Ld</u>	IEC	Snap		
47505	EK029C5I				IEC	Grabber (Clip)		

## ECG Trunk Cable and Leads for Patient monitor



Compatible Brand	Productor Guide	OEM P/N	REF NO.	Description (Name,Length,Leads,)	Color coding / Leads	Patient end termination
<b>SPACELABS</b>  166	suitable for all TRU-LINK Plug System , Yoke type: TRU-LINK style, Code: <u>L</u>	700-0007-00	EL024S3A	TUR-LINK style lead wires, <b>24 in. (61 cm) , 3-Ld</b>	AHA (AAMI)	Snap
		700-0007-04	EL024S4A	TUR-LINK style lead wires, <b>24 in. (61 cm) , 4-Ld</b>	AHA (AAMI)	Snap
		700-0006-04	EL024C4A		AHA (AAMI)	Grabber (Clip)
		700-0007-05	EL024S4I		IEC	Snap
		700-0006-05	EL024C4I		IEC	Grabber (Clip)
		700-0007-08	EL024S5A	TUR-LINK style lead wires, <b>24 in. (61 cm) , 5-Ld</b>	AHA (AAMI)	Snap
		700-0007-09	EL024S5I		IEC	Snap
		700-0006-09	EL024C5I		IEC	Grabber (Clip)
		700-0007-12	EL024S6A	TUR-LINK style lead wires, <b>24 in. (61 cm) , 6-Ld</b>	AHA (AAMI)	Snap
		700-0006-12	EL024C6A		AHA (AAMI)	Grabber (Clip)
		700-0007-13	EL024S6I		IEC	Snap
		700-0006-13	EL024C6I		IEC	Grabber (Clip)
		700-0007-16	EL024S10A	TUR-LINK style lead wires, <b>24 in. (61 cm) , 10-Ld</b>	AHA (AAMI)	Snap
		700-0006-16	EL024C10A		AHA (AAMI)	Grabber (Clip)
		700-0007-17	EL024S10I		IEC	Snap
		700-0006-17	EL024C10I		IEC	Grabber (Clip)
		700-0007-03	EL040S3I	TUR-LINK style lead wires, <b>40 in. (102 cm) , 3-Ld</b>	IEC	Snap
		700-0006-03	EL040C3I	TUR-LINK style lead wires, <b>40 in. (102 cm) , 4-Ld</b>	IEC	Grabber (Clip)
		700-0007-06	EL040S4A		AHA (AAMI)	Snap
		700-0006-06	EL040C4A		AHA (AAMI)	Grabber (Clip)
		700-0007-07	EL040S4I		IEC	Snap
		700-0006-07	EL040C4I	TUR-LINK style lead wires, <b>40 in. (102 cm) , 5-Ld</b>	IEC	Grabber (Clip)
		700-0007-10	EL040S5A		AHA (AAMI)	Snap
		700-0006-10	EL040C5A		AHA (AAMI)	Grabber (Clip)
		700-0007-11	EL040S5I	TUR-LINK style lead wires, <b>40 in. (102 cm) , 6-Ld</b>	IEC	Snap
		700-0006-11	EL040C5I		IEC	Grabber (Clip)
		700-0007-14	EL040S6A	TUR-LINK style lead wires, <b>40 in. (102 cm) , 10-Ld</b>	AHA (AAMI)	Snap
		700-0006-14	EL040C6A		AHA (AAMI)	Grabber (Clip)
		700-0007-15	EL040S6I		IEC	Snap
		700-0006-15	EL040C6I		IEC	Grabber (Clip)
700-0007-18	EL040S10A	TUR-LINK style lead wires, <b>40 in. (102 cm) , 10-Ld</b>	AHA (AAMI)	Snap		
700-0006-18	EL040C10A		AHA (AAMI)	Grabber (Clip)		
700-0007-19	EL040S10I		IEC	Snap		
700-0006-19	EL040C10I		IEC	Grabber (Clip)		

One-Piece Series EKG Cable With Leads

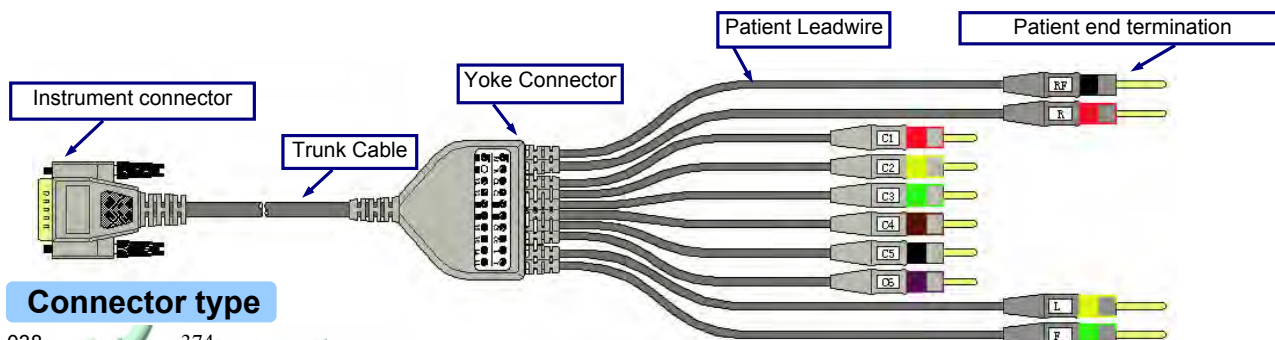

Connector type



Lead Position Marked

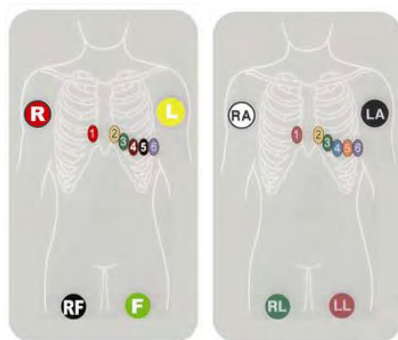

12 Lead: I  
Standard IEC

12 Lead: A  
Standard AHA

S: Standard Snap



C: Clip (type RL Grabber)



D: Din 3.0



B: Banana 4.0



One-Piece Series EKG Cable With Leads



Compatible Brand	Compatible Models No.	INSTRUMENT CONNECTOR	REF NO.	STANDARD	Defibrillation withstand	PATIENT END TERMINAL
<b>Bosch Cambridge Custo-med DEGO Hellige Siemens Von Berg (hormann)</b>	Bosch:603 D, 603 ER, 603 S, 606 Cambridge: CM 6000, CM 6400 Custo-med: Custo-card DEGO: Cardiomed 3 Hellige: EK 36, EK 41, EK 43, EK 53, EK 56, EK 403, EK 413, EK 512, EK 512 E, EK 512 P, Cardiosmart, CardioSys, Corna Siemens:Cardiostat1/3T/703/710/31/31 S Cardina C, Cardirex 3T/4/6T/62, Cathcor, Megacard Elema A/B, R, R/E, Mingodoc, Mingocard 3 / 4 / 7, Mingograph 4 / 62 / 81 Mingograph 82 / 740, Mingolog 7, Mingophon 3/7/310/410/420/710/720, Miracard 1, Sirecard440/440S/460/460S/740 Siereg, Sirecard 803, Sirecust 701 Von Berg: Bioset3500/3600/3700/6000/8000	291 	VA029CNA	AHA,	No Resistance,	Clip,
			VA029DNA	AHA,	No Resistance,	Din3.0,
			VA029BNA	AHA,	No Resistance,	Banana
			VA029SAA	AHA,	4.7kΩ Resistance,	Snap,
			VA029DAA	AHA,	4.7kΩ Resistance,	Din3.0
			VA029CNI	IEC,	No Resistance,	Clip,
			VA029DNI	IEC,	No Resistance,	Din3.0,
			VA029BNI	IEC,	No Resistance,	Banana
			VA029DAI	IEC,	4.7kΩ Resistance,	Din3.0
			VA029BAI	IEC,	4.7kΩ Resistance,	Banana
<b>Hellige</b>	<b>Hellige: EK 51</b>	036 	VA011CBA	AHA,	10 kΩ Resistance,	Clip
			VA011DBI	IEC,	10 kΩ Resistance,	Din3.0
<b>Avionics(Del Mar) Custo-med Del mar Ergoline Esaote Biomedica Fidelity Innomed Kontron Reynolds Schiller Bionet</b>	Avionics(Del Mar): 910 / 920 / 930 / 940 / 942 / 950 / 960 / 970 / 980 Custo-med: Custo-norm Del mar: 910,920,930,940,942,950, 960,970,980 Ergoline: Autoruler, Autoscript 6/12 Cardiette, EK 3003 / 3012, Ergoline Esaote Biomedica: EKG P120 Fidelity: LP 3000 Innomed: Heart Mirror (3-Kanal) Kontron: EKG P80 Reynolds: Cardiotrack 12 Schiller:AT3, AT5, AT6,AT10, AT60, AT104 PC, AT104, AT101 CS6, CS12,CS100, CS200 Trentina: All Excel-Types Von Berg: Bioset 9000 Bionet:All models	036 Short Screw 	VA021SNA	AHA,	No Resistance,	Snap,
			VA021BNA	AHA,	No Resistance,	Banana
			VA021BBA	AHA,	10 kΩ Resistance,	Banana
			VA021BDA	AHA,	10 kΩ+discharge tube,	Banana
			VA021CNI	IEC,	No Resistance,	Clip,
			VA021BNI	IEC,	No Resistance,	Banana
			VA021CBI	IEC,	10 kΩ Resistance,	Clip
			VA021DBI	IEC,	10 kΩ Resistance,	Din3.0
			VA021BBI	IEC,	10 kΩ Resistance,	Banana
			VA021BBI			
<b>Schiller Esaote Biomedica</b>	<b>Schiller:</b> AT-2 Plus, AT1, AT2, AT4, AT101, AT102 <b>Esaote Biomedica:</b> P80, P80Power, P80PowerSix	9.5mm Long Screw 	VA022SBA	AHA,	10 kΩ Resistance,	Snap,
			VA022CBA	AHA,	10 kΩ Resistance,	Clip
			VA022DBA	AHA,	10 kΩ Resistance,	Din3.0
			VA022BBA	AHA,	10 kΩ Resistance,	Banana
			VA022SBI	IEC,	10 kΩ Resistance,	Snap,
			VA022CBI	IEC,	10 kΩ Resistance,	Clip
			VA022DBI	IEC,	10 kΩ Resistance,	Din3.0
			VA022BBI	IEC,	10 kΩ Resistance,	Banana



One-Piece Series EKG Cable With Leads

Compatible Brand	Compatible Models No.	INSTRUMENT CONNECTOR	REF NO.	STANDARD	Defibrillation withstand	PATIENT END TERMINAL
<b>Bosch / dimeq</b> <b>Cambridge</b> <b>Cardioline/Remco</b> <b>Cardionics</b> <b>Hellige</b> <b>Honeywell/Philips:</b> <b>Polymed</b> <b>Schwarzer</b> <b>SECA</b>	Bosch/dimeq: 501A,501NV,503,601 503B,503D,503NV,503V,506,506D, Cambridge: VS 6, SC 1000 Delta 1 / 3 / 300 / 360, E 1 / E 1 R / E 3 Cardionics: all Models Hellige: Corina. EK 51 Honeywell/Philips: Cardioplan, CR 300, CR 330, ER 330 Polymed: Alpha 600 / 800 Schwarzer: VS 6 SECA: 3000	028 	VA004SAA	AHA,	4.7kΩ Resistance, Snap,	
			VA004CAA	AHA,	4.7kΩ Resistance, Clip	
			VA004DAA	AHA,	4.7kΩ Resistance, Din3.0	
			VA004BAA	AHA,	4.7kΩ Resistance, Banana	
			VA004SAI	IEC,	4.7kΩ Resistance, Snap,	
<b>Burdick</b> <b>Quinton</b> <b>ATRIA</b>	BURDICK (QUINTON):Eclipse 4, Eclipse 400,Eclipse 8, Eclipse 800, Eclipse 850, Eclipse 850i, Eclipse Plus, Eclipse LE II BURDICK with serial number starting with 1067 or 92304 ATRIA: ATRIA PLUS, ATRIA3000	162 	VA005CBA	AHA,	10 kΩ Resistance, Clip	
			VA005DBA	AHA,	10 kΩ Resistance, Din3.0	
			VA005BBA	AHA,	10 kΩ Resistance, Banana	
			VA005CBI	IEC,	10 kΩ Resistance, Clip	
			VA005DBI	IEC,	10 kΩ Resistance, Din3.0	
			VA005BBI	IEC,	10 kΩ Resistance, Banana	
<b>Burdick</b>	EK-10	039 	VA002CNA	AHA,	No Resistance, Clip,	
			VA002BNA	AHA,	No Resistance, Banana	
			VA002SNI	IEC,	No Resistance, Snap,	
			VA002CNI	IEC,	No Resistance, Clip,	
			VA002DNI	IEC,	No Resistance, Din3.0,	
	VA002BNI	IEC,	No Resistance, Banana			
	Burdick: Elite, Elite II, E-350, E550, E560, (1st Generation Eclipse LE/LEi, with serial number starting with 1051). Burdick #007705, Stress cable with detachable leads 007706 Fukuda Denshi: Alpha 500 / 600, FCP 2201	028 	VA004SAA	AHA,	4.7kΩ Resistance, Snap,	
			VA004CAA	AHA,	4.7kΩ Resistance, Clip	
			VA004DAA	AHA,	4.7kΩ Resistance, Din3.0	
			VA004BAA	AHA,	4.7kΩ Resistance, Banana	
VA004SAI			IEC,	4.7kΩ Resistance, Snap,		
<b>EDAN</b>	SE-12 Express SE-3 SE-601A	038 	VA030SBA	AHA,	10 kΩ Resistance, Snap,	
			VA030CBA	AHA,	10 kΩ Resistance, Clip	
			VA030DBA	AHA,	10 kΩ Resistance, Din3.0	
			VA030BBA	AHA,	10 kΩ Resistance, Banana	
			VA030CBI	IEC,	10 kΩ Resistance, Clip	
			VA030DBI	IEC,	10 kΩ Resistance, Din3.0	
VA030BBI	IEC,	10 kΩ Resistance, Banana				
<b>Fukuda Denshi</b>	Fukuda Denshi Autocardiner, Cardimax FX-2111 / FX-3010 / FX-4010, FCP-2155	034 	VA017BAA	AHA,	4.7kΩ Resistance, Banana	
			VA017DAI	IEC,	4.7kΩ Resistance, Din3.0	
			VA017BAI	IEC,	4.7kΩ Resistance, Banana	
<b>FUKUDA ME</b>	KP-500	165 	VA024CNA	AHA,	No Resistance, Clip,	
			VA024BNA	AHA,	No Resistance, Banana	
			VA024SNI	IEC,	No Resistance, Snap,	
			VA024CNI	IEC,	No Resistance, Clip,	
			VA024DNI	IEC,	No Resistance, Din3.0,	
	KP-500D		VA024SEA	AHA,	20kΩ+discharge, Snap,	
			VA024CEA	AHA,	20kΩ+discharge, Clip,	
			VA024DEA	AHA,	20kΩ+discharge, Din3.0,	
			VA024SEI	IEC,	20kΩ+discharge, Snap,	
			VA024CEI	IEC,	20kΩ+discharge, Clip,	
VA024DEI	IEC,	20kΩ+discharge, Din3.0,				

One-Piece Series EKG Cable With Leads



Compatible Brand	Compatible Models No.	INSTRUMENT CONNECTOR	REF NO.	STANDARD	Defibrillation withstand	PATIENT END TERMINAL	
<b>FUKUDA ME</b>	FX-031		VA014SNA	AHA,	No Resistance,	Snap,	
			VA014CNA	AHA,	No Resistance,	Clip,	
			VA014SNI	IEC,	No Resistance,	Snap,	
			VA014CNI	IEC,	No Resistance,	Clip,	
			VA014DNI	IEC,	No Resistance,	Din3.0,	
	Fukuda M-E: Cardisuny alpha 1000, Cardisuny alpha 6600 A / 6600 AX	028		VA004SAA	AHA,	4.7kΩ Resistance,	Snap,
				VA004CAA	AHA,	4.7kΩ Resistance,	Clip
				VA004DAA	AHA,	4.7kΩ Resistance,	Din3.0
				VA004BAA	AHA,	4.7kΩ Resistance,	Banana
				VA004SAI	IEC,	4.7kΩ Resistance,	Snap,
<b>KANZ PC-104, Cardioline remco</b>	Kanz: 103, 106 <b>Cardioline/remco:</b> delta 1,3,30,60 delta 1 plus, delta 3 plus, delta 60 plus	024	VA016CNA	AHA,	No Resistance,	Clip,	
			VA016DNA	AHA,	No Resistance,	Din3.0,	
			VA016BNA	AHA,	No Resistance,	Banana	
			VA016SAA	AHA,	4.7kΩ Resistance,	Snap,	
			VA016CAA	AHA,	4.7kΩ Resistance,	Clip	
			VA016SNI	IEC,	No Resistance,	Snap,	
			VA016DNI	IEC,	No Resistance,	Din3.0,	
			VA016BNI	IEC,	No Resistance,	Banana	
<b>Kanz PC-109</b>	ECG 108/110/1203,1205	033	VA015SNA	AHA,	No Resistance,	Snap,	
			VA015CNA	AHA,	No Resistance,	Clip,	
			VA015BNA	AHA,	No Resistance,	Banana	
			VA015CNI	IEC,	No Resistance,	Clip,	
			VA015DNI	IEC,	No Resistance,	Din3.0,	
			VA015BNI	IEC,	No Resistance,	Banana	
<b>Marquette (GEMS)</b>	Hellige: MicroSmart, MAC 500 / 1100 MAC 1200 / 1200 ST	029	VA008CBA	AHA,	10 kΩ Resistance,	Clip	
			VA008BBA	AHA,	10 kΩ Resistance,	Banana	
			VA008BBI	IEC,	10 kΩ Resistance,	Banana	
<b>MEDICAL RESEARCH LABS (MRL)</b>	MEDICAL RESEARCH LABS (MRL): Portable Intensive Care (PIC) System		VA012SBA	AHA,	10 kΩ Resistance,	Snap,	
			VA012CBA	AHA,	10 kΩ Resistance,	Clip	
			VA012DBA	AHA,	10 kΩ Resistance,	Din3.0	
			VA012BBA	AHA,	10 kΩ Resistance,	Banana	
			VA012SBI	IEC,	10 kΩ Resistance,	Snap,	
			VA012CBI	IEC,	10 kΩ Resistance,	Clip3	
			VA012DBI	IEC,	10 kΩ Resistance,	Din3.0	
VA012BBI	IEC,	10 kΩ Resistance,	Banana				
<b>MEDTRONIC PHYSIO CONTRO</b>	MEDTRONIC PHYSIO CONTROL: Lifepak 12	224	VA013SBA	AHA,	10 kΩ Resistance,	Snap,	
			VA013CBA	AHA,	10 kΩ Resistance,	Clip	
			VA013DBA	AHA,	10 kΩ Resistance,	Din3.0	
			VA013BBA	AHA,	10 kΩ Resistance,	Banana	
			VA013SBI	IEC,	10 kΩ Resistance,	Snap,	
			VA013DBI	IEC,	10 kΩ Resistance,	Din3.0	
<b>Mindray</b>	BeneView ( 12-Ld module)  Oem p/n:0010-30-42721 ( AAMI std.)  Oem p/n:0010-30-42722 ( IEC std.)		VA020SBA	AHA,	1 kΩ Resistance,	Snap,	
			VA020CBA	AHA,	1 kΩ Resistance,	Clip	
			VA020DBA	AHA,	1 kΩ Resistance,	Din3.0	
			VA020BBA	AHA,	1 kΩ Resistance,	Banana	
			VA020SBI	IEC,	1 kΩ Resistance,	Snap,	
			VA020CBI	IEC,	1 kΩ Resistance,	Clip	
VA020DBI	IEC,	1 kΩ Resistance,	Din3.0				















One-Piece Series EKG Cable With Leads

Compatible Brand	Compatible Models No.	INSTRUMENT CONNECTOR	REF NO.	STANDARD	Defibrillation withstand	PATIENT END TERMINAL			
<b>MORTARA</b>	MORTARA INSTRUMENT:ELI 100 MORTARA INSTRUMENT:ELI 50 MORTARA INSTRUMENT:ELI 200		VA025SAA	AHA,	4.7kΩ Resistance, Snap,				
			VA025BAA	AHA,	4.7kΩ Resistance, Banana				
			VA025SAI	IEC,	4.7kΩ Resistance, Snap,				
			VA025CAI	IEC,	4.7kΩ Resistance, Clip				
			VA025DAI	IEC,	4.7kΩ Resistance, Din3.0				
			VA025BAI	IEC,	4.7kΩ Resistance, Banana				
	Martara Surveyor		223	VA035SBI	IEC,	10 kΩ Resistance, Snap,			
<b>NEC</b>	YY-1063		VA003SBA	AHA,	10 kΩ Resistance, Snap,				
			VA003CBA	AHA,	10 kΩ Resistance, Clip				
			VA003DBA	AHA,	10 kΩ Resistance, Din3.0				
			VA003BBA	AHA,	10 kΩ Resistance, Banana				
			VA003SBI	IEC,	10 kΩ Resistance, Snap,				
			VA003CBI	IEC,	10 kΩ Resistance, Clip				
			VA003DBI	IEC,	10 kΩ Resistance, Din3.0				
VA003BBI	IEC,	10 kΩ Resistance, Banana							
<b>Nihon Kohden</b> <b>Biocare</b> <b>DongJiang 东江</b>	Nihon Kohden: ECG-9620/9010/9020 ECG-9022/9110/9130/9132/ ECG-8420(Except 9320 ) 115/1250/1350/1550/9010 K BIOCARE: ECG-101/101G/300 ECG-300G, ECG-1200, ECG-9803. CMICS: ECG-11A, ECG-11B, ECG-11D ECG-32A, ECG-32A(II), ECG-120		VA001SNA	AHA,	No Resistance, Snap,				
			VA001CNA	AHA,	No Resistance, Clip,				
			VA001DNA	AHA,	No Resistance, Din3.0,				
			VA001BNA	AHA,	No Resistance, Banana				
			VA001SNI	IEC,	No Resistance, Snap,				
			VA001CNI	IEC,	No Resistance, Clip,				
			VA001DNI	IEC,	No Resistance, Din3.0,				
			VA001BNI	IEC,	No Resistance, Banana				
			<b>Nihon Kohden</b>	BSM-2301, BSM-2353, BSM-5100, Supply Code No. K901 Article No. BJ-900P		VA036SNI	IEC,	No Resistance, Snap,	
						VA036CNI	IEC,	No Resistance, Clip,	
<b>Nihon Kohden</b>	Nihon Kohden: Cardiofax6151/6353, Cardiofax EKG-8270/8350/8370/8420 8423/8450/8453/8820/8823/8830/9130 115/1250/1350/1550/9010 K Cardiofax-Q		VA001CAA	AHA,	4.7kΩ Resistance, Clip				
			VA001DAA	AHA,	4.7kΩ Resistance, Din3.0				
			VA001BAA	AHA,	4.7kΩ Resistance, Banana				
			VA001SAI	IEC,	4.7kΩ Resistance, Snap,				
			VA001DAI	IEC,	4.7kΩ Resistance, Din3.0				
			VA001BAI	IEC,	4.7kΩ Resistance, Banana				
	Cardiofax Q ECG-9110K Cardiofax Q ECG-9130K ECG-9130P, ECG-9620P special screw, imperial standard(SAE)		VA009SNA	AHA,	No Resistance, Snap,				
			VA009BNA	AHA,	No Resistance, Banana				
			VA009DNI	IEC,	No Resistance, Din3.0,				
			VA009BNI	IEC,	No Resistance, Banana				
ECG-9320 ECG-9522P (Original part No.: BR-911D)		VA010SCA	AHA,	20 kΩ Resistance, Snap,					
		VA010CCA	AHA,	20 kΩ Resistance, Clip					
		VA010DCA	AHA,	20 kΩ Resistance, Din3.0					
		VA010BCA	AHA,	20 kΩ Resistance, Banana					
		VA010SCI	IEC,	20 kΩ Resistance, Snap,					
		VA010CCI	IEC,	20 kΩ Resistance, Clip					
		VA010DCI	IEC,	20 kΩ Resistance, Din3.0					
		VA010BCI	IEC,	20 kΩ Resistance, Banana					
<b>PETAS</b>		222	VA023SNA	AHA,	No Resistance, Snap,				
		VA023CNA	AHA,	No Resistance, Clip,					
		VA023DNA	AHA,	No Resistance, Din3.0,					
		VA023BNA	AHA,	No Resistance, Banana					
		VA023SNI	IEC,	No Resistance, Snap,					
		VA023CNI	IEC,	No Resistance, Clip,					
		VA023DNI	IEC,	No Resistance, Din3.0,					
VA023BNI	IEC,	No Resistance, Banana							

### EKG Multi-link Cable and Lead wires











Compatible Brand	Compatible Models No.	OEM P/N	REF NO.	Description (Name,Length,Plug,Standard)	INSTRUMENT CONNECTOR	Yoke
<b>Fukuda</b>			VJ032-EAI	12-Lead ECG Trunk Cable, 12pin>>2p*10 Euro Yoke, L=2.2m, <b>AAMI/IEC</b> , 20kΩ Res.+discharge Fit Euro type leadwires	384 	385 
<b>Hellige GE-Marquette</b>	MicroSmart, MAC 500 / 1100 / 1200 / 1200 ST	223 418 08	VE008-BAI	MAC1200 10Ld EKG Trunk Cable, L=2.2m, DB15M>VS 10L Yoke <b>AAMI/IEC</b> , 10kΩ Res.		031 
<b>GE-Medical</b>	For GE Eagle, Solar, Dash , Tram, MAC-Lab Cath Lab System, Datex-Ohmeda S/5 FM, Original P/N: (AAMI: E9002ZH, 416035-001) (IEC: E9002ZJ, 416035-002)		VE006-BAI	Multi-Link 12-Ld ECG cable L=2.2m, Rectangle 11p>VS 10L Yoke <b>AAMI/IEC</b> , 1kΩ Res.	518 	699 
<b>Avionics(Del Mar) Custo-med Del mar Ergoline Esaote Biomedica Fidelity Innomed Kontron Reynolds Schiller Trentina (Ellettronica) Von Berg Bionet Welch allyn,</b>	<b>Avionics(Del Mar):</b> 910/920/930 /940/942/950/960/970/980 , <b>Custo-med:</b> Custo-norm, <b>Ergoline:</b> Autoruler, Autoscript 6/12, Cardiette, EK 3003 / 3012, Ergoline; <b>Esaote Biomedica:</b> EKG P120, <b>Fidelity:</b> LP 3000, <b>Innomed:</b> Heart Mirror(3-Kanal), <b>Kontron:</b> EKG P80, <b>Reynolds:</b> Cardiotrack 12, <b>Schiller:</b> AT3, AT5, AT6,AT10, AT60, AT104 PC, AT104, CS6, CS12,CS100, CS200 <b>Trentina:</b> All Excel-Types, Von Berg: Bioset 9000		VE021-NAI	Schiller 10Ld EKG Trunk Cable,L=2.2m DB15M>VS 10L Yoke <b>AAMI/IEC</b> , <b>no</b> Res.	036 	
<b>Mindray</b>	PM-7000/PM-9000Super/PM-9000Express (12 LEAD ECG MODULE) BeneView Oem p/n:0010-30-42721 (AAMI ) Oem p/n:0010-30-42722 (IEC)	0010-30-42721	VE020-BAI	Mindray 10Ld EKG Trunk Cable,L=2.2m Round 12p>VS 10L Yoke <b>AAMI/IEC</b> , 1kΩ Res.		
<b>Spacelabs</b>	TRU-LINK Accessories for 90496 Module	700-0008-01	VE027-BAI	Spacelabs 10Ld EKG Trunk Cable,L=2.2m Round 17p>VS 10L Yoke <b>AAMI/IEC</b> , 1 kΩ Res.	022 	

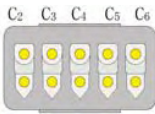
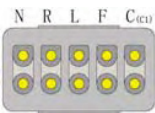
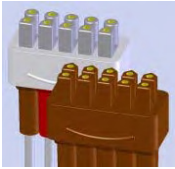

EKG Multi-link Cable and Lead wires

www.bmtmedikal.com.tr





LEAD WIRES

Compatible Brand	Compatible Models No.	OEM P/N	REF NO.	Description (Name,Length,Plug,)	Color coding Standard	Patient end termination
<b>Hellige GE-Marquette</b>  140	suitable for all MultiLink-Plug 	384 018 16	VE008SNA	10-Ld Set patient leads, 4 x limb lead (130cm), 6 x chest leads (70cm), , no Resistance, VS-2P plug	AHA (AAMI)	Snap
			VE008BNA		AHA (AAMI)	Banana
			VE008SNI		IEC	Snap
			VE008CNI		IEC	Grabber (Clip)
			VE008BNI		IEC	Banana
<b>GE-Medica</b> Holter Multi-Link Leadwire Sets – For GE SEER MC Holter Recorder For GE Eagle, Solar, Dash Monitors, Tram, MAC-Lab Cath Lab System, Datex-Ohmeda S/5 FM  C <sub>2</sub> C <sub>3</sub> C <sub>4</sub> C <sub>5</sub> C <sub>6</sub>  N R L F C <sub>(c)</sub>		E9008KC	EE051S5A	Multi-Link Ldwr Set, 5Ld,L=130cm, <b>AHA</b>	AHA (AAMI)	Snap
		416468-001 E9008KG	EW051S5A	Multi-Link Ldwr Set,5-Ld, Snap, V2-V6, <b>AHA</b> , 51 in. (130cm)	AHA (AAMI)	Snap
		E9008KE	EE051S5I	Multi-Link Ldwr Set, 5Ld,L=130cm, <b>IEC</b>	IEC	Snap
		416468-002 E9008KH	EW051S5I	Multi-Link Ldwr Set, 5Ld, Snap, C2-C6, <b>IEC</b> , 51 in. (130cm)	IEC	Snap
<b>GE medical</b> For GE MAC PC, MAC 6, MAC 12, MAC 15, MAC VU, CASE 12, CASE 15, CASE 16, MAX-Personal, MAX-1, CENTRA Systems with AM4 or AM5 Acquisition Module  136			VF008SNA	10-Ld Set patient leads, 4 x limb lead (130cm), 6 x chest leads (70cm), , no Resistance, L-2P plug	AHA (AAMI)	Snap
			VF008CNA		AHA (AAMI)	Grabber (Clip)
			VF008DNA		AHA (AAMI)	Din 3.0 plug
			VF008SNI		IEC	Snap
			VF008CNI		IEC	Grabber (Clip)
<b>CONMED JINJIANG</b> Cardio Beats Jinjiang Electronic Tech instrument: LEAD2000, GE electrophysiology machine  325			VG019SNA	10-Ld Set patient leads, 4 x limb lead (130cm), 6 x chest leads (70cm), , no Resistance, 2P plug	AHA (AAMI)	Snap
			VG019DNA		AHA (AAMI)	Din 3.0 plug
			VG019CNI		IEC	Grabber (Clip)
			VG019DNI		IEC	Din 3.0 plug
			VG019BNI		IEC	Banana
<b>PHILIPS medical</b> Use with Philips Instrument M1700A M1701A M1702A; TRIM II, Trim 1, 2, 3  552		M1713B	VX018BNA	 VX018BNA	AHA (AAMI)	Banana
		M1716B	VX018BNI		IEC	Banana



## EKG Multi-Link Cable and Leadwires



### EKG Multi-Link Cable



Compatible Brand	Compatible Models No.	OEM P/N	REF NO.	Description (Name,Length,Plug,Standard)	INSTRUMENT CONNECTOR	Yoke
<b>MEDTRONIC PHYSIO CONTRO</b>	Medtronic Physio Control: Lifepak 12		VR013-BAI	12-Lead ECG Trunk Cable, 12pin>>LL4+7pin Yoke, L=2.0m, AAMI/IEC, 10kΩ Res. Fit LL 4LD leadwires and VR024S6A, VR024S6I		
<b>Spacelabs</b>	90496 Ultraview Module		VR027-EAI	12-Lead ECG Trunk Cable, 17pin>>LL4+7pin Yoke, L=2.0m, AAMI/IEC, 1kΩ Res Fit LL 4LD leadwires and VR024S6A, VR024S6I		

### EKG Multi-Link Lead set





Compatibility	Compatible Models No.	OEM P/N	REF NO.	Description (Name,Length,Plug,Standard)	Diagram
<b>EKG Multi-Link Cable</b>	Medtronic Physio Control: Lifepak 12, Zoll medical: R Series Monitor Defibrillators		VR024S6A	AAMI 6-Ld ECG leadwires, 7pin>>6*Snap, L=1.15m,	
			VR024S6I	IEC 6-Ld ECG leadwires, 7pin>>6*Snap, L=1.15m,	
<b>EKG Multi-Link Cable</b>	Medtronic Physio Control: Lifepak 12, Zoll medical: R Series Monitor Defibrillators		VB051S4A	AAMI 4-LD ECG leadwires, LL 2pin >> 4*Snap, L=1.0m,	
			VB051S4I	IEC 4-LD ECG leadwires, LL 2pin >> 4*Snap, L=1.0m,	

ECG Electrodes



Compatible Brand	Productor Guide	OEM P/N	REF NO.	Description
all Monitoring/ Telemetry/ Electrocardiograph instrument		GEMS OEM P/N: E9001BG	V0014CP	Disposable Paediatric ECG Electrodes, Cloth Round, 40mm diameter, wet gel, snap electrode. Silver/silver chloride (Ag/AgCl) sensor, repositionable. – packaging (film/disc): 1000
		GEMS P/N: E9007SG	V0014A	Disposable Adult ECG Electrodes, Cloth Round, 2”(50mm) diameter, wet gel, snap electrode. Silver/silver chloride (Ag/AgCl) sensor, repositionable. – packaging (film/disc): 1000







● Suction ECG electrodes

Compatible Brand	Productor Guide	OEM P/N	REF NO.	Description
All Resting ECG Recommended for Nihon Konden, GE,Philips		Nihon konden: H043	V0013AB	Adult suction electrode, – perfect fit for <b>3.0mm Din plug or 0.156-in.(4mm) banana plug</b> – Latex-free, – Adult size replacement bulb for all 21mm diameter electrodes. Bulb diameter is 26mm. – Metal Electrodes: Nickel-plate. – 1 box = 6 bulbs
All Resting ECG Recommended for Nihon Konden, GE,Philips			V0013A-P	Paediatric suction electrode, – perfect fit for <b>3.0mm Din plug</b> leadwires – Latex-free, – Adult size replacement bulb for all 17mm diameter electrodes. Bulb diameter is 23mm. – Metal Electrodes: Nickel-plate. – 1 box = 6 bulbs
			V0013B-P	Paediatric suction electrode, – perfect fit for <b>0.156-in.(4mm) banana plug</b> leadwires – Latex-free – Adult size replacement bulb for all 17mm diameter electrodes. Bulb diameter is 23mm. – Metal Electrodes: Nickel-plate. – 1 box = 6 bulbs
All Resting ECG Recommended for GE-Marquette, Schiller, Mortala, Burdick, Philips		HP OEM ON:40419A	V0013C-A	Adult suction Ag/AgCl electrode, – perfect fit for <b>3.0mm Din plug or 0.156-in.(4mm) banana plug or (4mm)Snap</b> leadwires – Adult size replacement bulb for all 24mm diameter electrodes. Bulb volume is 5cc.(dia.32mm) – Metal Electrodes: <b>Ag/AgCl</b> . – 1 box = 6 bulbs
		HP OEM ON:40422A	V0013C-P	Paediatric suction Ag/AgCl electrode, – perfect fit for <b>3.0mm Din plug or 0.156-in.(4mm) banana plug or (4mm)Snap</b> leadwires – Adult size replacement bulb for all 17mm diameter electrodes. Bulb volume is <b>2cc</b> . (dia.23mm) – Metal Electrodes: <b>Ag/AgCl</b> . – 1 box = 6 bulbs

## ECG Electrodes



### ● Limb Clamp ECG Electrodes

Compatible Brand	Productor Guide	OEM P/N	REF NO.	Description
all Resting ECG Recommended for Nihon Konden, Fukuda, NEC, Kenz, China		Nihon konden: H068K	V0012A	Limb clamp electrode, clothespin type – perfect fit for <b>3.0mm Din plug</b> leads – Metal Electrodes: Nickel-plate. – 1 box = 4 electrodes – Color coding: IEC, red(R), yellow(L), black(RF), green(F)
			V0012B-I	Limb clamp electrode, clothespin type perfect fit for <b>0.156-in.(4mm) banana plug</b> leads – Metal Electrodes: Nickel-plate.. – 1 box = 4 electrodes – Color coding:IEC, red(R), yellow(L), black(RF), green(F)
			V0012B	Limb clamp electrode, clothespin type – perfect fit for <b>0.156-in.(4mm) banana plug</b> leadwires – Metal Electrodes: Nickel-plate. – 1 box = 4 electrodes – Color coding:AHA,white(RA), black(LA), green(RL), red(LL)
all Resting ECG Recommended for GE-Marquette, Schiller, Bionet, Mortala, Burdick	 335	HP OEM ON:40494E	V0012M-I	Adult Limb clamp Ag/AgCl electrode, clothespin type – perfect fit for <b>3.0mm Din plug or 0.156-in.(4mm) banana plug or (4mm)Snap</b> leadwires – Metal Electrodes: Ag/AgCl. – 1 box = 4 electrodes – Color coding standard: <b>IEC</b> , red(R), yellow(L), black(RF), green(F)
			V0012M-A	Adult Limb clamp Ag/AgCl electrode, clothespin type – perfect fit for <b>3.0mm Din plug or 0.156-in.(4mm) banana plug or (4mm)Snap</b> leadwires – Metal Electrodes: Ag/AgCl. – 1 box = 4 electrodes – Color coding : <b>AHA</b> , white(RA),black(LA),green(RL),red(LL)
all Resting ECG Recommended for GE-Marquette, Schiller, Bionet, Mortala, Burdick			V0012M-IP	Paediatric Limb clamp Ag/AgCl electrode, clothespin type – perfect fit for <b>3.0mm Din plug or 0.156-in.(4mm) banana plug or (4mm)Snap</b> leadwires – Metal Electrodes: Ag/AgCl. – 1 box = 4 electrodes – Color coding standard: <b>IEC</b> , red(R), yellow(L), black(RF), green(F)
			V0012M-AP	Paediatric Limb clamp Ag/AgCl electrode, clothespin type – perfect fit for <b>3.0mm Din plug or 0.156-in.(4mm) banana plug or (4mm)Snap</b> leadwires – Metal Electrodes: Ag/AgCl. – 1 box = 4 electrodes – Color coding : <b>AHA</b> , white(RA),black(LA),green(RL),red(LL)



Holter Recorder ECG Patient Cable and Leads

www.bmtmedikal.com.tr









Compatible Brand	Compatible Models No.	OEM P/N	NO.	Description (Name,Length,Leads,)	Color coding / Leads	Patient end termination
<b>GE-Marquette Rozinn</b>			HA021S3A	3-Ld lead wires,40 in.	AHA	Snap
<b>GE-SEER Light</b>		200859 4-001	HA053S5A	SEER Light Holter Patient Cable/Leadwires,5-Ld	AHA	Snap
		200859 4-002	HA053S7A	SEER Light Holter Patient Cable/Leadwires,7-Ld	AHA	Snap
		200859 4-004	HA053S7I	SEER Light Holter Patient Cable/Leadwires,7-Ld	IEC	Snap
<b>Mindray</b> TMS-6016 Telemetry monitoring system			HA052S5A	5Ld lead wires, <b>40 in. (102 cm) , 5-Ld</b> PLUG: 1.5mm*5pin	AHA	Snap
<b>Mbelec</b> CD2000-1800			HA052S3A	3Ld lead wires, <b>40 in. (102 cm) , 3-Ld</b> PLUG: 1.5mm*5pin	AHA	Snap
<b>NEC</b>		YCE- 205	HA001S3I	YCE205 lead wires, <b>30 in. (76 cm) , 3-Ld</b>	IEC	Snap
			HA001C3I		IEC	Grabber
		47502	HA002S3I	47502 lead wires, <b>30 in. (76 cm) , 3-Ld</b>	IEC	Snap
<b>Nihon konden</b>		BR- 546S	HA004S3I	3Ld lead wires, <b>40 in. (102 cm) , 3-Ld</b> PLUG: Din2.0*3pin	IEC	Snap
			HA004C3I		IEC	Grabber
<b>PI</b>			HA048S4I	4-Ld lead wires, <b>40 in. (102 cm)</b> , PLUG: HRS-4P	IEC	Snap
			HA048S6I	6-Ld lead wires, <b>40 in. (102 cm)</b> , PLUG: HRS-6P	IEC	Snap
<b>Philips</b>			HA056S5A	Telemetry monitoring leads <b>40 in. (102 cm)</b> ,	AAMI	Snap
			HA056S5I	Telemetry monitoring leads <b>40 in. (102 cm)</b> ,	IEC	Snap
<b>Din 1.5 Style Normal</b>	suitable for all Din-Plug System , Yoke type: Din style,Code: <b>C</b>		EC018S3A	Din lead wires, <b>18 in. (45 cm) , 3-Ld</b>	AHA (AAMI)	Snap
			EC018S3I		IEC	Snap
			EC018S5A	Din lead wires, <b>18 in. (45 cm) , 5-Ld</b>	AHA (AAMI)	Snap
			EC018C5A		AHA (AAMI)	Grabber
			EC018C5I		IEC	Grabber

## Holter Recorder ECG Patient Cable and Leads

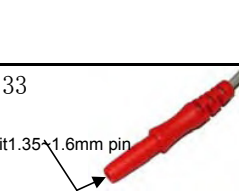

## LEAD WIRES

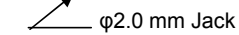
Unshielded lead wires have the 1.5 mm (.060) DIN socket injection molded at one end and a snap, Grabber injection molded at the other. The snap termination's ergonomic, teardrop design reduces tangling at the patient end connector. Pinch and neo-pinch terminations have dual sided metal contacts to ensure the connection in flex-reliefs.

Compatible Brand	Compatible Models No.	OEM P/N	NO.	Description (Name,Length,Leads,)	Color coding / Leads	Patient end termination			
Din 1.5 Style Normal	suitable for all Din-141   EC024S3A		EC024S3A	Din lead wires, <b>24 in. (61 cm) , 3-Ld</b>	AHA (AAMI)	Snap			
			EC024C3I		IEC	Grabber			
			EC024S5A		AHA (AAMI)	Snap			
			EC024C5A		AHA (AAMI)	Grabber			
			EC024S5I		IEC	Snap			
			EC024C5I		IEC	Grabber			
			EC040S3A		AHA (AAMI)	Snap			
			EC040C3A		AHA (AAMI)	Grabber			
			EC040S3I		IEC	Snap			
			EC040C3I		IEC	Grabber			
			EC040S5A		AHA (AAMI)	Snap			
			EC040C5A		AHA (AAMI)	Grabber			
		EC040S5I		IEC	Snap				
		EC040C5I		IEC	Grabber				
		 EC024S5I		HC018S7A		AHA (AAMI)	Snap		
			HC018C7A		AHA (AAMI)	Grabber			
			HC018S7I		IEC	Snap			
			HC018C7I		IEC	Grabber			
			 EC040S7A		HC024S7A		AHA (AAMI)	Snap	
				HC024C7A		AHA (AAMI)	Grabber		
				HC024S7I		IEC	Snap		
				HC024C7I		IEC	Grabber		
				 EC040S7A		HC040S7A		AHA (AAMI)	Snap
					HC040C7A		AHA (AAMI)	Grabber	
			HC040S7I			IEC	Snap		
			HC040C7I			IEC	Grabber		
		 EC040S10			HC018S10A		AHA (AAMI)	Snap	
			HC018C10A			AHA (AAMI)	Grabber		
			HC018S10I		IEC	Snap			
			HC018C10I		IEC	Grabber			
	 EC040S10			HC024S10A		AHA (AAMI)	Snap		
			HC024C10A		AHA (AAMI)	Grabber			
		HC024S10I		IEC	Snap				
		HC024C10I		IEC	Grabber				
		 EC040S10		HC040S10A		AHA (AAMI)	Snap		
			HC040C10A		AHA (AAMI)	Grabber			
			HC040C10I		IEC	Grabber			
Contec, Meigaoyi	133 fit 1.35x1.6mm pin 		HC040S7A-G	Din lead wires, <b>40 in. (102 cm) , 7-Ld</b>	AHA (AAMI)	Snap			
			HC040S10A-G	Din lead wires, <b>40 in. (102 cm) , 10-Ld</b>	AHA (AAMI)	Snap			
Din 2.0 Jack Style Biomedical system: DH 073	suitable for all Din 2.0 Jack System , Yoke type: Din 2.0 Jac style, Code: S 132  φ2.0 mm Jack		HS024S7A	Din 2.0 lead wires, <b>24 in. (61 cm) , 7-Ld</b>	AHA (AAMI)	Snap			
			HS024C7A		AHA (AAMI)	Grabber			
			HS040C7A		AHA (AAMI)	Grabber			



Non-Invasive Blood Pressure(NIBP) Cuff & Tubes

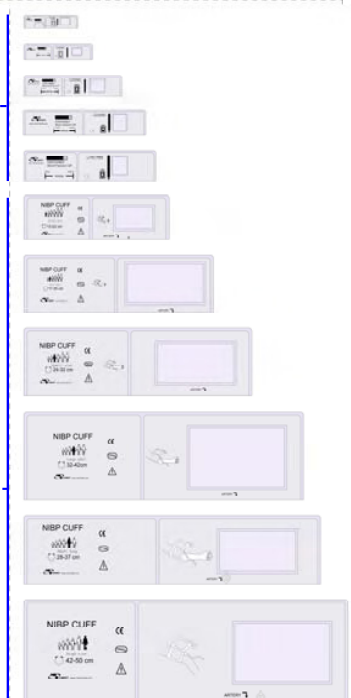
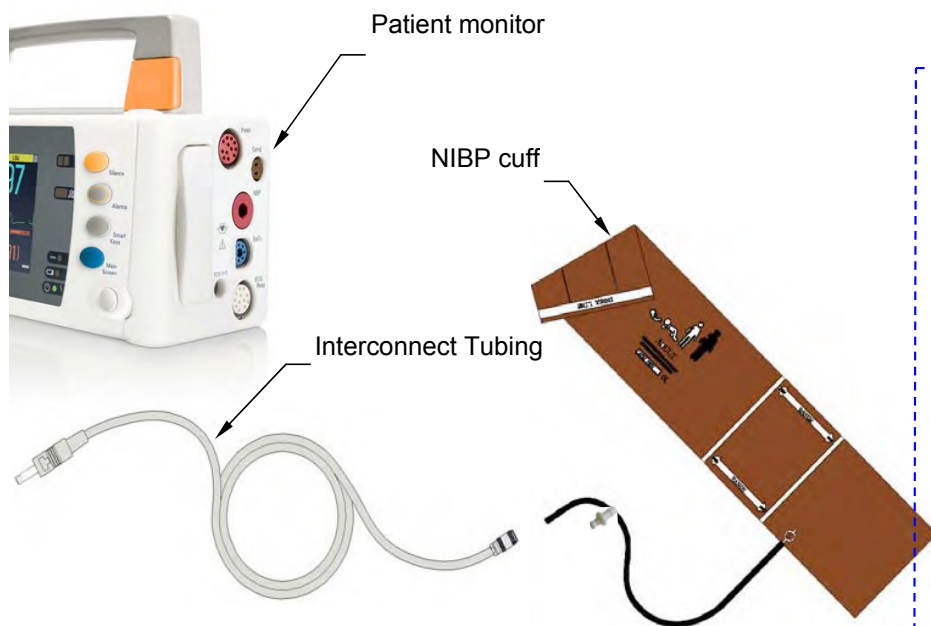

Comfort Reusable Cuffs    Bladderless Reusable Cuffs    Neo Disposable Cuffs    Disposable Cuffs

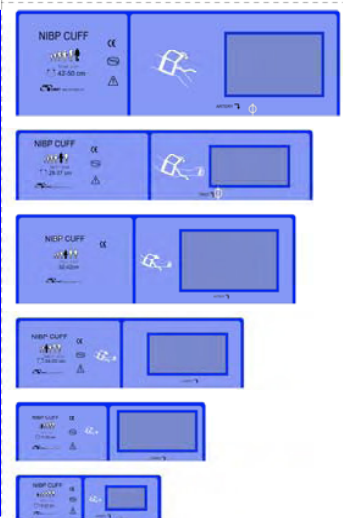

Instrument Connector



Patient Side Connector



Cuff Connector

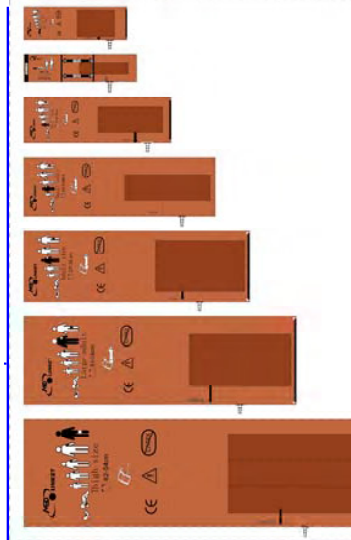

Non-Invasive Blood Pressure(NIBP) Cuff & Tubes



**Bladderless Reusable Blood Pressure Cuffs**

**Specifications**

- Gentle Nylon+TPU, strong enough for repeated inflation
- Reusable for multiple patient use
- Convenient and easy to clean
- Easy-to-use range markers and index line for proper size and placement
- Extra hook and loop for added security
- Variety of connection types to fit multiple monitoring systems
- Latex-free,
- PVC-free



Compatible Brand	Product Guide	OEM P/N	Model No	Description (Name,Length,Plug)
<p><b>Philips</b> 78352A/C, 78354A/C,M1008A/B M1176A,M1350B,M3000A M3001A (with M1598B, M1599B, tubing) <b>Colin , Datascope -</b> Passport, Acutor; <b>Fukada Denshi;</b> <b>Spacelabs</b> : all; <b>Oider welch-Allyn</b> : Models-with locking luer-type connector, <b>Criticare</b> ,; <b>Siemens</b>- with bayonet type connector; <b>Mindray,</b> <b>Goldway,</b></p>	<p>One-Tube "Monitor"单管型</p>		Y000RLA1	Bladderless Reusable Blood Pressure Cuffs, Large Adult size, One-Tube, Arm width min/max [cm]=32~42cm, Packaging:1 piece/pk;
			Y000RT1	Bladderless Reusable Blood Pressure Cuffs, Thigh size,One-Tube, Arm width min/max [cm]=42~50cm, Packaging:1 piece/pk;
			Y000RA1	Bladderless Reusable Blood Pressure Cuffs, Adult size, One-Tube, Arm width min/max [cm]=24~32cm, Packaging:1 piece/pk;
			Y000RAL1	Bladderless Reusable Blood Pressure Cuffs, Adult long size, One-Tube, Arm width min/max [cm]=28~37cm, Packaging:1 piece/pk;
			Y000RC1	Bladderless Reusable Blood Pressure Cuffs, <b>Child size</b> , One-Tube, Arm width min/max [cm]=15~22cm, Packaging:1 piece/pk;
			Y000RSA1	Bladderless Reusable Blood Pressure Cuffs, Small Adult size, One-Tube, Arm width min/max [cm]=17~25cm, Packaging:1 piece/pk;
<p><b>GE-Marquette,</b> <b>Datex-Ohmeda</b> <b>GE(Marquette)</b> with male quick-connect type connector, Dinama plus, XL,SX/XP,8100 series, Each GE corometrics; <b>Critikon;</b> <b>Datex-</b> <b>Ohmeda</b>-with one male and one female quick connect type connector; <b>CAS;</b> <b>New</b> <b>Welch-Allyn</b> vital signs models-with threaded type Critikon style connector</p>	<p>Two-Tube "Monitor"双管型</p>		Y000RLA2	Bladderless Reusable Blood Pressure Cuffs, Large Adult size, two-Tube, Arm width min/max [cm]=32~42cm, Packaging:1 piece/pk;
			Y000RT2	Bladderless Reusable Blood Pressure Cuffs, Thigh size,two-Tube, Arm width min/max [cm]=42~50cm, Packaging:1 piece/pk;
			Y000RA2	Bladderless Reusable Blood Pressure Cuffs, Adult size, two-Tube, Arm width min/max [cm]=24~32cm, Packaging:1pcs/pack,
			Y000RAL2	Bladderless Reusable Blood Pressure Cuffs, Adult long size, two-Tube, Arm width min/max [cm]=28~37cm, Packaging:1pcs/pack,
			Y000RC2	Bladderless Reusable Blood Pressure Cuffs, Child size, two-Tube, Arm width min/max [cm]=15~22cm, Packaging:1 piece/pk;
			Y000RSA2	Bladderless Reusable Blood Pressure Cuffs, Small Adult size, two-Tube, Arm width min/max [cm]=17~25cm, Packaging:1 piece/pk;



















Non-Invasive Blood Pressure(NIBP) Cuff & Tubes

Pressure Cuff Interconnect Tubing

Compatible Brand	Compatible Models No.	OEM P/N	REF NO.	Description (Name,Length,Plug)	Instrument Connector	Yoke (cuff side)
Philips	Connects all sizes of Philips' reusable and disposable adult and pediatric NIBP cuffs to the monitor. Use with adult and pediatric cuffs only. CANNOT BE USED WITH NEONATAL CUFFS. Use with all Philips models except A1/A3	M1598B	YA25A06-05	Pressure Cuff Interconnect Tubing, Single tube, 5ft.1.5M, 6.0 Air plug > Bayonet type, perfect fit for 5082-184 cuff connector	 347	 348
		M1599B	YA25A06-10	Pressure Cuff Interconnect Tubing, Single tube, 10ft. 3.0M, 6.0 Air plug > Bayonet type, perfect fit for 5082-184 cuff connector	 347	 348
Philips Simens Mindray Spacelabs MEK,NPB , Contec	NIBP hose connects to 40401X, M45xx, M157x series pressure cuffs. Use with Philips Instrument: A1/A3, M3921A, M3923A, M3926A, M3927A, M3928A, M3929A SpaceLabs:90496 Module, Contec: CMS9000	M3918A SpaceLabs P/N:714-0018-00	YA06A06-10	Pressure Cuff Interconnect Tubing, Single tube, 10 ft 3.0 M, Bayonet type > Bayonet type perfect fit for 5082-184 cuff connector	 348	 348
			YA06A06-12	Pressure Cuff Interconnect Tubing, Single tube, 12 ft 3.6 M, Bayonet type > Bayonet type perfect fit for 5082-184 cuff connector	 348	 348
Goldway 3F Medical System			YA10A01-12	Blood Pressure Tubing (Air Hoses), single-tube, Adult-Pediatric, 12 ft., Screw Connector > Barbed to barbed connector.	 514	 514
Creative Neusoft Jeteem	Jeteem:BD6000		YA18A01-10	Pressure Cuff Interconnect Tubing, Single tube, 3.0M, Readet Air plug> Barbed to barbed connector.	 319	 319
Colin, Criticare, CSI Datascope, NihonKohden, Datascope			YA07A08-10	Pressure Cuff Interconnect Tubing, Single tube, 3.0M, Male Plastic Luer Lock> Female Plastic Luer Lock.	 514	 514
GE Dinamap, Pro, MPS	DINAMAP, Pro, Compact, MPS Series	107365	YA24A10-12	Blood Pressure Tubing (Air Hoses), two- tube, Adult-Pediatric, 12 ft., Gray Shroud to Screw Connector, Gray.	 516	 514
		107366	YA24A10-24	Blood Pressure Tubing (Air Hoses), two- tube, Adult-Pediatric, 24 ft., Gray Shroud to Screw Connecto.	 516	 514
		107368	YA24A16-12	Blood Pressure Tubing (Air Hoses), two- tube, Neonatal, 12 ft., Gray Shroud to Female Slip Lue.	 516	 514
		107363	YA24A12-12	Blood Pressure Tubing (Air Hoses), two- tube, Adult-Pediatric, 12 ft., Gray Shroud to Submin Connector, Gray	 516	 382

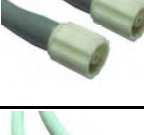
## Non-Invasive Blood Pressure(NIBP) Cuff &amp; Tubes



Compatible Brand	Compatible Models No.	OEM P/N	REF NO.	Description (Name,Length,Plug)	Instrument Connector	Yoke (cuff side)
GE Marquette	Eagle 3000, Dash 2000/3000/4000, Tram 400/450/451, Tram 800. 850/851. Corometrics 120	9461-217	YA23A10-12	Blood Pressure Tubing (Air Hoses), two- tube, Adult-Pediatric, 12 ft.Gray, Rectangular Connector to Screw Connector,	381 	514 
		414873-001	YA23A12-12	Blood Pressure Tubing (Air Hoses), two- tube, Adult-Pediatric, 12 ft., Gray, Rectangular Connector to Submin Connector.	381 	
		414874-001	YA23A16-08	Blood Pressure Tubing (Air Hoses), two- tube, Neonatal, 8 ft., Rectangular Connector to Female Slip Luer.	381 	
GE medical Critikon, Kontron, Invivo	DINAMAP 1846, 8100, 9300 and Plus Series Monitors	88845	YA10A102-24	Blood Pressure Tubing (Air Hoses), two- tube, Adult-Pediatric, 24 ft., Screw Connector to Screw Connector.	514 	514 
		88845	YA10A12-08	Blood Pressure Tubing (Air Hoses), two- tube, Neonatal, 8 ft., Screw Connector to Female Slip Luer.		
GE medical Corometrics GE Datex	Eagle 4000, Tram 100/200/250/300/350, Corometrics 120	9461-203	YA22A12-12	Blood Pressure Tubing (Air Hoses), two- tube, Adult-Pediatric, 12 ft., Screw Connector to Submin Connecto.	507 	
		9461-214	YA22A10-12	Blood Pressure Tubing (Air Hoses), two- tube, Adult-Pediatric, 12 ft., Screw Connector to Screw Connector.	507 	
		9461-205	YA22A16-08	Blood Pressure Tubing (Air Hoses), two- tube, Neonatal, 8 ft., Round Connector to Female Slip Luer.	507 	
Nihon Kohden	Bedside Monitor: BSM-4101, 4103, 4111, 4113 Life scope P, BSM-5105, 5135 Life scope A, BSM-2351, 2353 Life scope L, BSM-2301, 2303 Life scope I		YA28A11-08	Blood Pressure Tubing (Air Hoses), two- tube, 8 ft. (2.4m), A28>A11, Fit for A12.		
Siemens, Drager	Multimed-Pot system fur serie SC 6000, SC 6002XL, SC 7000, SC 9000, Art. Nr. 3368391 (8. 2ft) Art. Nr. 5950196 (4. 9ft)		YA29A06-08	Blood Pressure Tubing (Air Hoses), single-tube, 8ft (2. 4m), A29>A06, fit for A04, A05.		



Non-Invasive Blood Pressure(NIBP) Cuff & Tubes

**Air Hose Connectors (Cuff side)**



Air Hose Connectors

- Air hose connectors to convert your air hose to use blood pressure cuffs
- Variety of shapes and styles
- Economical way to standardize your blood pressure monitors throughout your facility.

Compatibility	Productor Guide	OEM P/N	REF NO.	Description	Perfect fit for
Unfitted			HL0024B	Single Tubing, <b>Black</b> , Inner diameter: 5/32 in. Out diameter: 6mm, Purchasing Unit: M - Material: Silicone	all Barbed diameter 5/32 in. air connector
Unfitted		GE P/N:300959	SL0008A	Single Tubing, <b>Gray</b> , Φ6.0X3.0mm Purchasing Unit: M - Material: TPU	all Barbed diameter 5/32 in. air connector
Unfitted			SL0008B	Two-Tubing, Gray, Inner diameter: 5/32 in. Out diameter: 6mm*2, Purchasing Unit: M - Material: TPU	all Barbed diameter 5/32 in. air connector
Air Hose Connector		GE P/N:300670	A01	Barbed to Barbed, Plastic, Packaging: <b>10pcs/pk</b> Fit for ID2.5mm - 4.0mm tube.	all Barbed diameter 5/32 in. air connector
L&T, Critikon, Datex (Neonatal)		Welchallyn P/N:5082-176	A26	Barbed to Male Luer Slip type, Plastic, Packaging: <b>10pcs/pk</b> , Fit for ID2.5mm tube.	Female Slip Luer (A03,A15,A16)
L&T, Critikon, Datex		GE P/N:300667 Welchallyn P/N:5082-167	A25	5/32 in. ID Barbed to Male Slip Luer, Plastic, Packaging: 10pcs/pk Fit for ID4.0mm tube and OD4.0 tube.	Female Slip Luer (A03,A15,A16)
L & T		GE P/N:300667 Welchallyn P/N:5082-167	A02	5/32 in. ID Barbed to Male Slip Luer, Metal, Packaging: 10pcs/pk Fit for ID4.0mm tube	Female Slip Luer (A03,A15,A16)
L & T		GE P/N:300669 Welchallyn P/N:5082-169	A03	5/32 in. ID Barbed to Female Slip Luer, Metal, Packaging: 10pcs/pk Fit for ID4.0mm tube	Male Slip Luer, (A02,A25,A26)
Philips (HP), Siemens, Datascope and Colin		GE P/N:330059 Welchallyn P/N:5082-184	A04	Male Bayonet to 5/32 in. ID Barbed, Metal, Packaging: <b>10pcs/pk</b> Fit for ID4.0mm tube	Female Bayonet
		Welchallyn P/N:5082-184	A05	Male Bayonet to 5/32 in. ID Barbed, Plastic, Packaging: <b>10pcs/pk</b> Fit for ID2.5mm - 4.0mm tube.	Female Bayonet
		GE P/N:330060	A06	5/32 in. ID Barbed to Female Bayonet, Metal, Packaging: 1piece/pk Fit for ID3.0mm - 4.0mm tube.	Male Bayonet

## Non-Invasive Blood Pressure(NIBP) Cuff &amp; Tubes



Compatibility	Productor Guide	OEM P/N	REF NO.	Description	Perfect fit for
Spacelabs, Datascope and Colin		GE P/N:30066 8 Welch- allyn P/N:5082- 168	A07	(Plastic Luer Lock) Female Locking Luer to 5/32 in. ID Barbed, Plastic, Packaging: <b>10pcs/pk</b> Fit for ID3.0mm - 4.0mm tube.	Male Locking Luer
		GE P/N:30066 5 Welch- allyn P/N:5082- 165	A08	5/32 in. ID Barbed to Male Locking Luer (Plastic Luer Lock), Plastic, Packaging: <b>10pcs/pk</b> Fit for ID2.5mm - 4.0mm tube.	Female Locking Luer
DINAMAP		GE P/N:30066 4 Welch- allyn P/N:5082- 164	A09	Male Screw to 5/32 in. ID Barbed, Plastic, Packaging: 10pcs/pk Fit for ID2.5mm - 4.0mm tube.	Female Screw
		GE P/N:30061 9 Welch- allyn P/N:5082- 161	A10	5/32 in. ID Barbed to Female Screw, Plastic, Packaging: 10pcs/pk Fit for ID2.5mm - 4.0mm tube.	Male Screw
GE, Marquette and Protocol		GE P/N:3300 64 Welch- allyn P/N:5082- 182	A11	(Quick Disconnect Locking type) Female Submin to 5/32 in. ID Barbed, Plastic, Packaging: <b>10pcs/pk</b> Fit for ID2.5mm - 4.0mm tube.	Male Submin
GE, Marquette, Datex-Ohmeda		GE P/N:3300 90	A12	(Quick Disconnect Locking type) Male Submin to 5/32 in. ID Barbed, Plastic, Packaging: <b>10pcs/pk</b> Fit for ID2.5mm - 4.0mm tube.	Female Submin
Marquette one-tube systems		GE P/N:33005 7 Welch- allyn P/N:5082- 181	A13	5/32 in. ID Barbed to Female Marquette locking type Connector, Plastic, Packaging: 1piece/pk Fit for ID2.5mm - 4.0mm tube.	male Marquette locking type Connector
			A14	5/32 in. ID Barbed to male Marquette locking type Connector, Plastic, Packaging: 1piece/pk Fit for ID2.5mm - 4.0mm tube.	Female Marquette locking type Connector
ADAPTER			A15	5/32 in. ID Barbed X2 to Female Slip Luer,, Plastic, Packaging: <b>10pcs/pk</b> Fit for ID2.5mm - 4.0mm tube.	Marquette Neonatal cuff connector
			A21	5/32 in. ID Barbed X2 to 5/32 in. ID Barbed X2, Plastic, Packaging: <b>10pcs/pk</b> Fit for ID2.5mm - 4.0mm tube.	5/32 in. ID Tube
			SL0424A	Y type tube adaptor, ID: 4.0mm, OD: 7.0mm	single tube to double tube style Interconnect Tubing
Eagle 3000, Dash 2000/3000/4000, Tram 400/450/451, Tram 800/850/851			A16	5/32 in. ID Barbed to Female Slip Luer, Plastic, Packaging: 10pcs/pk Fit for ID2.5mm - 4.0mm tube.	Marquette Neonatal cuff connector



Non-Invasive Blood Pressure(NIBP) Cuff & Tubes

Air Hose Connectors (Instrument side)

Compatibility	Product Guide	OEM P/N	REF NO.	Description	Perfect fit for
Readel			A17	5/32 in. ID Barbed to Readel air socket, Plastic, Packaging: 1piece/pk	Readel air plug
			A18	5/32 in. ID Barbed to Readel air plug, Plastic, Packaging: 1piece/pk Fit for ID4.0mm tube.	Readel air socket,
Philips			A19	Male Bayonet socket to 5/32 in. ID Barbed, Metal, L=29mm, Packaging: 1piece/pk Fit for ID4.0mm tube.	Female Bayonet
			A20	Male Bayonet socket to 5/32 in. ID Barbed, Metal, L=38mm, Packaging: 1piece/pk Fit for ID4.0mm tube.	Female Bayonet
Marquette		GE P/N:330 057	A13	5/32 in. ID Barbed to Female Marquette locking type socket, Plastic, Packaging: 1piece/pk	male Marquette locking type Connector
			A14	5/32 in. ID Barbed to male Marquette locking type Connector, Plastic, Packaging: 1piece/pk	Female Marquette locking type socket
Eagle 4000, Tram 100/200/250/300/350, Corometrics 118			A22	5/32 in. ID Barbed*2 to Round Connector, Packaging: 1piece/pk	Perfect fit for two-tubes
Eagle 3000, Dash 2000/3000/4000, Tram 400/450/451, Tram 800/850/851, Corometrics 120			A23	Rectangular Connector, Packaging: 1piece/pk	Perfect fit for two-tubes
DINAMAP, Pro, Compact, MPS Series			A24	Gray Shroud Connector, Packaging: 1piece/pk	Perfect fit for two-tubes
Regularly as the connector of air hose for neonate disposable BP cuffs		GE P/N: 300669 Welch-allyn P/N: 5082-169	A30	5/32 in. ID Barbed to Female Slip Luer, Metal, Packaging: 1pcs/pk Fit for ID4.0mm tube	Male Slip Luer, (A02,A25,A26)

IBP Cable and Pressure Transducers

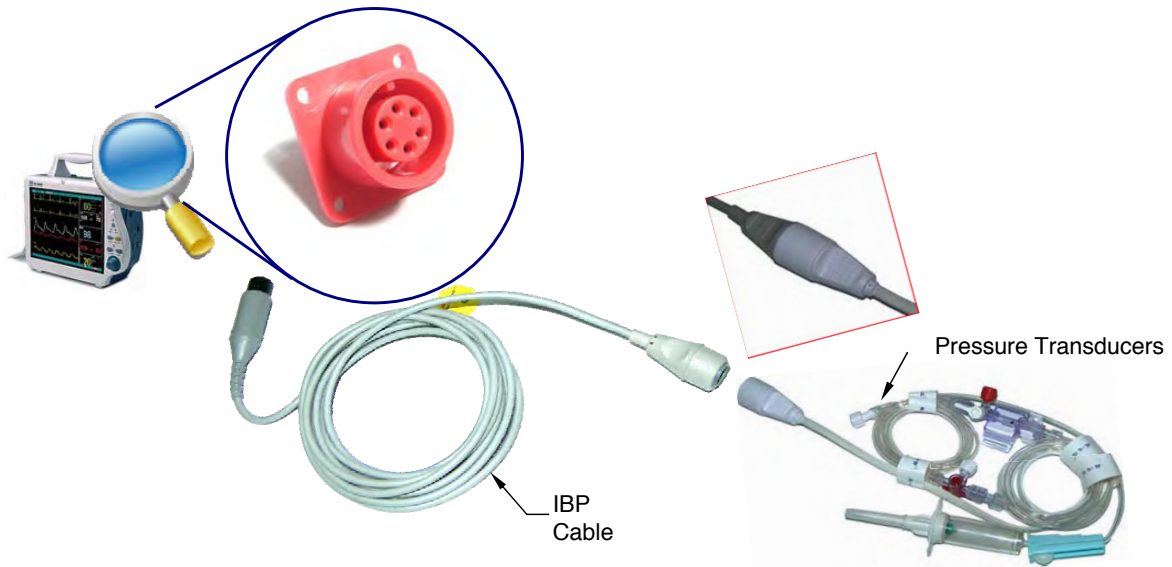

**Instrument Connector**

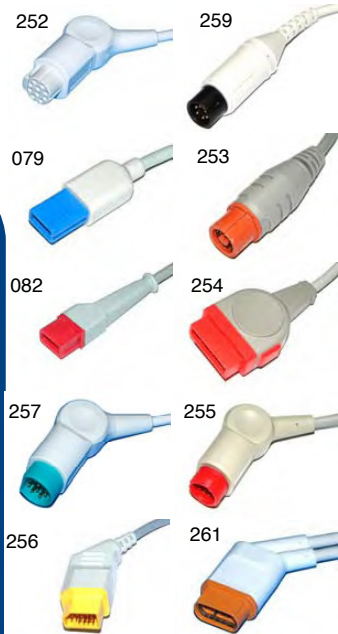

**Yoke type**



- A**: Abbott connector RJ11-6P6C Jack
- B**: Utah connector Din 1.5 Plug
- C**: Edward/Baxter connector 5pin Plug
- D**: BD/Ohmeda connector Round 7J Plug
- E**: MAXXIM connector 5pin Plug
- F**: Philips /B.Bruan connector 4J Plug
- G**: pvb / SIMMS connector 5 pin Plug
- J**: Medex 950 connector RJ11-6P6C Jack













































**transducers connector**



- Abbott Medex 950 transducers
- Utah transducers
- Edward Baxter transducers
- BD/Ohmeda transducers
- MAXXIM transducers
- Philips transducers
- pvb / SIMMS transducers



































IBP Cable and Pressure Transducers



Compatible Brand	Compatible Models No.	OEM P/N	REF NO.	Description (Name,Length,Plug)	INSTRUMENT CONNECTOR	Yoke ( transducers side)
<b>GE- Marquette</b>	GE Solar, Dash, Eagle, Tram  		X0014A	Abbott Transducer Adapter Cable, 12 ft. (3.6M), Rectangle 11pin>6p6c jack,	413 	
		700078-001	X0014B	Utah Transducer Adapter Cable, 12 ft. (3.6M), Rectangle 11p>Din2.0 4p	413 	
			X0014C	Edward Transducer Adapter Cable, 12 ft. (3.6M), Rectangle 11pin>5pin,	413 	
			X0014D	BD Transducer Adapter Cable, 12 ft. (3.6M), Rectangle 11pin>7p jack,	413 	
			X0014E	MAXXIM Transducer Adapter Cable, 12 ft. (3.6M), Rectangle 11pin>5pin	413 	
			X0014F	Philips Transducer Adapter Cable, 12 ft. (3.6M), Rectangle 11pin>Round 4p	413 	
			X0014J	Medex Transducer Adapter Cable, 12 ft. (3.6M), Rectangle 11pin>6p6c jack,	413 	
<b>Lohmeier</b>	M010  		X0019A	Abbott Transducer Adapter Cable, 12 ft. (3.6M), Rectangle 12p>6p6c jack,	079 	
			X0019B	Utah Transducer Adapter Cable, 12 ft. (3.6M), Rectangle 12p>Din 2.0 4pin	079 	
			X0019C	Edward Transducer Adapter Cable, 12 ft. (3.6M), Rectangle 12p>5pin,	079 	
			X0019D	BD Transducer Adapter Cable, 12 ft. (3.6M), Rectangle 12p>7p jack,	079 	
			X0019E	MAXXIM Transducer Adapter Cable, 12 ft. (3.6M), Rectangle 12p>5pin	079 	
			X0019F	Philips Transducer Adapter Cable, 12 ft. (3.6M), Rectangle 12p>Round 4p	079 	
			X0019J	Medex Transducer Adapter Cable, 12 ft. (3.6M), Rectangle 12p>6p6c jack,	079 	
<b>Mindray</b>	PM6000,6800, T5, T8  		X0016A	Abbott Transducer Adapter Cable, 12 ft. (3.6M), Round 12pin>6p6c jack,	030 	
			X0016B	Utah Transducer Adapter Cable, 12 ft. (3.6M), Round 12pin>Din 2.0 4pin	030 	
			X0016C	Edward Transducer Adapter Cable, 12 ft. (3.6M), Round 12pin>5pin,	030 	
			X0016D	BD Transducer Adapter Cable, 12 ft. (3.6M), Round 12pin>7p jack,	030 	
			X0016E	MAXXIM Transducer Adapter Cable, 12 ft. (3.6M), Round 12pin>5pin	030 	
			X0016F	Philips Transducer Adapter Cable, 12 ft. (3.6M), Round 12pin>Round 4p	030 	
			X0016J	Medex Transducer Adapter Cable, 12 ft. (3.6M), Round 12pin>6p6c jack,	030 	

IBP Cable and Pressure Transducers

















































Compatible Brand	Compatible Models No.	OEM P/N	REF NO.	Description (Name,Length,Plug)	INSTRUMENT CONNECTOR	Yoke (transducers side)
Spacelabs Mindray Goldway	<p>Reusable and non-sterile. It may be gas sterilized. (Datex-Ohmeda TC-VTK.) For use with 690-0008-00, 690-0009-00, 690-0010-00, 690-0011-00, 690-0014-01, and 690-0015-01 transducers and all Spacelabs Medical monitoring systems. Use on 90496 also requires adapter cable 700-0028-00, sold separately.</p> <p><b>Mindray:</b> PM7000, 8000,9000,6201.</p> 		X0015A	Abbott Transducer Adapter Cable, 12 ft. (3.6M), AMP 6pin>6p6c jack,		
			X0015B	Utah Transducer Adapter Cable, 12 ft. (3.6M), AMP 6pin>Din 2.0 4pin		
			X0015C	Edward Transducer Adapter Cable, 12 ft. (3.6M), AMP 6pin>5pin,		
		690-0021-00	X0015D	BD Transducer Adapter Cable, 12 ft. (3.6M), AMP 6pin>7p jack,		
			X0015E	MAXXIM Transducer Adapter Cable, 12 ft. (3.6M), AMP 6pin>6pin		
			X0015F	Philips Transducer Adapter Cable, 12 ft. (3.6M), AMP 6pin>Round 4p		
			X0015J	Medex Transducer Adapter Cable, 12 ft. (3.6M), AMP 6pin>6p6c jack,		
Philips	<p>M1567A,M1568A kits</p> 		X0018A	Abbott Transducer Adapter Cable, 12 ft. (3.6M), Round 12pin>6p6c jack,	519 	
			X0018B	Utah Transducer Adapter Cable, 12 ft. (3.6M), Round 12pin>Din 2.0 4pin	519 	
			X0018C	Edward Transducer Adapter Cable, 12 ft. (3.6M), Round 12pin>5pin,	519 	
			X0018D	BD Transducer Adapter Cable, 12 ft. (3.6M), Round 12pin>7p jack,	519 	
			X0018E	MAXXIM Transducer Adapter Cable, 12 ft. (3.6M), Round 12pin>5pin	519 	
		M1634A	X0018F	Philips Transducer Adapter Cable, 12 ft. (3.6M), Round 12pin>Round 4p	519 	
			X0018J	Medex Transducer Adapter Cable, 12 ft. (3.6M), Round 12pin>6p6c jack,	519 	
Philips HP	<p>Philips: V24 HP</p>		X0039A	Abbott Transducer Adapter Cable, 12 ft. (3.6M), Round 12pin>6p6c jack,	519 	
			X0039J	Medex Transducer Adapter Cable, 12 ft. (3.6M), Round 12pin>6p6c jack,	519 	

















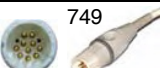

























IBP Cable and Pressure Transducers

www.bmtmedikal.com.tr

Compatible Brand	Compatible Models No.	OEM P/N	REF NO.	Description (Name,Length,Plug)	INSTRUMENT CONNECTOR	Yoke ( transducers side)
Siemens	Siemens Medical:Sirecust 700, Sirecust 630  X0001A 		X0001A	Abbott Transducer Adapter Cable, 12 ft. (3.6M), Round 10P>6p6c jack,	257 	
			X0001B	Utah Transducer Adapter Cable, 12 ft. (3.6M), Round 10P>Din 2.0 4pin	257 	
			X0001C	Edward Transducer Adapter Cable, 12 ft. (3.6M), Round 10P>5pin,	257 	
			X0001D	BD Transducer Adapter Cable, 12 ft. (3.6M), Round 10P>7p jack,	257 	
			X0001E	MAXXIM Transducer Adapter Cable, 12 ft. (3.6M), Round 10P>5pin	257 	
			X0001F	Philips Transducer Adapter Cable, 12 ft. (3.6M), Round 10P>Round 4p	257 	
			X0001J	Medex Transducer Adapter Cable, 12 ft. (3.6M), Round 10P>6p6c jack,	257 	
Siemens Drager	Siemens/Darger:SC6002XL,7000, SC8000,SC9000XL  X0002A  		X0002A	Abbott Transducer Adapter Cable, 12 ft. (3.6M), Round 7pin>6p6c jack,	258 	
			X0002B	Utah Transducer Adapter Cable, 12 ft. (3.6M), Round 7pin>Din 2.0 4pin	258 	
			X0002C	Edward Transducer Adapter Cable, 12 ft. (3.6M), Round 7pin>5pin,	258 	
			X0002D	BD Transducer Adapter Cable, 12 ft. (3.6M), Round 7pin>7p jack,	258 	
			X0002E	MAXXIM Transducer Adapter Cable, 12 ft. (3.6M), Round 7pin>5pin	258 	
			X0002F	Philips Transducer Adapter Cable, 12 ft. (3.6M), Round 7pin>Round 4p	258 	
			X0002J	Medex Transducer Adapter Cable, 12 ft. (3.6M), Round 7pin>6p6c jack,	258 	
Siemens	Siemens/Darge  X0031D  		X0031A	Abbott Transducer Adapter Cable, 12 ft. (3.6M), DB15M>6p6c jack,		
			X0031B	Utah Transducer Adapter Cable, 12 ft. (3.6M), DB15M>Din 2.0 4pin		
			X0031C	Edward Transducer Adapter Cable, 12 ft. (3.6M), DB15M>5pin,		
			X0031D	BD Transducer Adapter Cable, 12 ft. (3.6M), DB15M>7p jack,		
			X0031E	MAXXIM Transducer Adapter Cable, 12 ft. (3.6M), DB15M>5pin		
			X0031F	Philips Transducer Adapter Cable, 12 ft. (3.6M), DB15M>Round 4p		
			X0031J	Medex Transducer Adapter Cable, 12 ft. (3.6M), DB15M>6p6c jack,		



































## IBP Cable and Pressure Transducers



Compatible Brand	Compatible Models No.	OEM P/N	REF NO.	Description (Name,Length,Plug)	INSTRUMENT CONNECTOR	Yoke ( transducers side)
<b>Drager</b>	Drager PM8014 & PM8060		X0032A	Abbott Transducer Adapter Cable, 12 ft. (3.6M), Round 10pin>6p6c jack,	 749	
	 X0032B		X0032B	Utah Transducer Adapter Cable, 12 ft. (3.6M), Round 10pin>Din 2.0 4pin	 749	
			X0032C	Edward Transducer Adapter Cable, 12 ft. (3.6M), Round 10pin>5pin,	 749	
			X0032D	BD Transducer Adapter Cable, 12 ft. (3.6M), Round 10pin>7p jack,	 749	
			X0032E	MAXXIM Transducer Adapter Cable, 12 ft. (3.6M), Round 10pin>5pin	 749	
			X0032F	Philips Transducer Adapter Cable, 12 ft. (3.6M), Round 10pin>Round 4p	 749	
			X0032J	Medex Transducer Adapter Cable, 12 ft. (3.6M), Round 10pin>6p6c jack,	 749	
<b>Choice:</b>			X0033A	Abbott Transducer Adapter Cable, 12 ft. (3.6M), Redel 1-Rib 6p>6p6c jack,	 749	
			X0033B	Utah Transducer Adapter Cable, 12 ft. (3.6M), Redel 1-Rib 6p>Din 2.0 4P	 749	
			X0033C	Edward Transducer Adapter Cable, 12 ft. (3.6M), Redel 1-Rib 6p>5pin,	 749	
			X0033D	BD Transducer Adapter Cable, 12 ft. (3.6M), Redel 1-Rib 6p>7p jack,	 749	
			X0033E	MAXXIM Transducer Adapter Cable, 12 ft. (3.6M), Redel 1-Rib 6p>6pin	 749	
			X0033F	Philips Transducer Adapter Cable, 12 ft. (3.6M), Redel 1-Rib 6p>Round 4p	 749	
<b>Spacelabs Medical</b>	Compatible: Spacelab Ultraview 90496 , 91496 .		X0038A	Abbott Transducer Adapter Cable, 12 ft. (3.6M), 10 pin>6p6c jack,	 749	
	 X0038B		X0038B	Utah Transducer Adapter Cable, 12 ft. (3.6M), 10 pin>Din 2.0 4P	 749	
			X0038C	Edward Transducer Adapter Cable, 12 ft. (3.6M), 10 pin>5pin,	 749	
			X0038D	BD Transducer Adapter Cable, 12 ft. (3.6M), 10 pin>7p jack,	 749	
	 X0038E		X0038E	MAXXIM Transducer Adapter Cable, 12 ft. (3.6M), 10 pin>6pin	 749	
			X0038F	Philips Transducer Adapter Cable, 12 ft. (3.6M), 10 pin>Round 4p	 749	
			X0038J	Medex Transducer Adapter Cable, 12 ft. (3.6M), 10 pin>6p6c jack,	 749	

















IBP Cable and Pressure Transducers

Compatible Brand	Compatible Models No.	OEM P/N	REF NO.	Description (Name,Length,Plug)	INSTRUMENT CONNECTOR	Yoke ( transducers side)
<b>Nihon Konden</b>	BSM-73  		X0028A	Abbott Transducer Adapter Cable, 12 ft. (3.6M), Rectangle 14pin>6p6c jack,	256 	
			X0028B	Utah Transducer Adapter Cable, 12 ft. (3.6M), Rectangle 14pin>Din 2.0 4pin	256 	
			X0028C	Edward Transducer Adapter Cable, 12 ft. (3.6M), Rectangle 14pin>5pin,	256 	
			X0028D	BD Transducer Adapter Cable, 12 ft. (3.6M), Rectangle 14pin>7p jack,	256 	
			X0028E	MAXXIM Transducer Adapter Cable, 12 ft. (3.6M), Rectangle 14pin>5pin	256 	
			X0028F	Philips Transducer Adapter Cable, 12 ft. (3.6M), Rectangle 14pin>Round 4p	256 	
<b>MEK (KOREA)</b>			X0027A	Appott Transducer Adapter Cable, 12 ft. (3.6M), AMP 6pin 30°>6p6c jack,		
			X0027B	Utah Transducer Adapter Cable, 12 ft. (3.6M), AMP 6pin 30°>Din 2.0 4pin		
			X0027C	Edward Transducer Adapter Cable, 12 ft. (3.6M), AMP 6pin 30°>6pin,		
		690-0021-00	X0027D	BD Transducer Adapter Cable, 12 ft. (3.6M), AMP 6pin 30°>7p jack,		
			X0027E	MAXXIM Transducer Adapter Cable, 12 ft. (3.6M), AMP 6pin 30°>6pin		
			X0027F	Philips Transducer Adapter Cable, 12 ft. (3.6M), AMP 6pin 30°>Round 4p		
<b>DATASCOPE</b>	Datascope System 80, 82, 83, 84, 90, 90T, 95, 98, 97 IABP, 850, 870, P2, P3, 2000, 2000A., 2001, 2001A, 2002, 2002A, 2200I, 3000, Passport		X0041A	Appott Transducer Adapter Cable, 12 ft. (3.6M), AMP 6pin 30°>6p6c jack,	 	
			X0041B	Utah Transducer Adapter Cable, 12 ft. (3.6M), AMP 6pin 30°>Din 2.0 4pin		
			X0041C	Edward Transducer Adapter Cable, 12 ft. (3.6M), AMP 6pin 30°>6pin,		
			X0041D	BD Transducer Adapter Cable, 12 ft. (3.6M), AMP 6pin 30°>7p jack,		
			X0041E	MAXXIM Transducer Adapter Cable, 12 ft. (3.6M), AMP 6pin 30°>6pin		
			X0041F	Philips Transducer Adapter Cable, 12 ft. (3.6M), AMP 6pin 30°>Round 4p		













IBP Cable and Pressure Transducers

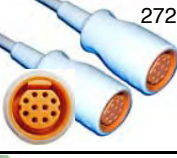

ADAPTER (Exchange pressure transducers type)

Compatible Brand	Compatible Models No.	OEM P/N	REF NO.	Description (Name,Length,Function)	Plug	Yoke ( transducers side)
<b>BD</b>	Compatible: All monitors that accept BD plugs 		X0034A	Pressure transducers Adapter, BD to Abbott		
			X0034B	Pressure transducers Adapter, BD to Utah		
			X0034J	Pressure transducers Adapter, BD to Medex		
<b>pvb</b>	Compatible: All monitors that accept pvb plugs		X0035A	Pressure transducers Adapter, pvb to Abbott		
			X0035B	Pressure transducers Adapter, pvb to Utah		
<b>Philips</b>	Compatible: All monitors that accept Philips plugs		X0036A	Pressure transducers Adapter, Philips to Abbott		
			X0036B	Pressure transducers Adapter, Philips to Utah		

ADAPTER CABLE

Compatible Brand	Compatible Models No.	OEM P/N	MED-LINK REF NO.	Description (Name,Length,Plug)	INSTRUMENT CONNECTOR	Yoke ( transducers side)
<b>Mennen</b>			X0025A	Adapter cable, pressure transducer interface cable, 35 cm, Round 8p>AMP 6J	015 	270 
		800-030-270	X0003A	Adapter cable, pressure transducer interface cable, 35 cm, Round 10p>2* 6J	260 	269 
<b>Siemens</b>		13646	X0004A	Adapter cable, pressure transducer interface cable, 35 cm, Rec16p> 2*Rou 10p	261 	272 
<b>Spacelabs Medical</b>	For use with the 90496 and 690-0021-00.	700-0028-00	X0024A	Adapter cable, pressure transducer interface cable, 122 cm/4 ft	082 	271 
<b>GE-Marquette</b>	GE Solar, Dash, Eagle, Tram 		X0014H	Adapter cable, pressure transducer interface cable, • Durable cable for extended cable life	413 	298 

IBP Cable and Pressure Transducers



DISPOSABLE PRESSURE TRANSDUCER

Compatible Brand	Productor Guide	Ttransducer Connector	REF NO.	Description
Abbott			X0020A	Pressure transducer kit for patientmount application, single-use Connector: RJ11-6P6C (No.: 262) Requires IBP adapter cable.
UTAH			X0020B	Pressure transducer kit for patientmount application, single-use Connector: 1.58 Jack x 4pin (No.: 263) Requires IBP adapter cable.
Edwards Baxter			X0020C	Pressure transducer kit for patientmount application, single-use Connector: 5pin (No.: 264) Requires IBP adapter cable.
BD / Ohmeda			X0020D	Pressure transducer kit for patientmount application, single-use Connector: Round 7pin (No.: 265) Requires IBP adapter cable.
MAXXIM			X0020E	Pressure transducer kit for patientmount application, single-use Connector: 5pin (No.: 267) Requires IBP adapter cable.
Philips B.Bruan			X0020F	Pressure transducer kit for patientmount application, single-use Connector: 1.0 x 4pin (No.: 268) Requires IBP adapter cable.
pvb / SIMMS			X0020G	Pressure transducer kit for patientmount application, single-use Connector: 1.5 Jack x 5pin Requires IBP adapter cable.

Respiratory Mechanics

Compatible Brand	Compatible Models No.	OEM P/N	REF No.	Description (Name, Length, Packages)	Productor Guide
Mindray	PM-9000series, PM-7000, PM-6000series, BeneView	9200-10-10530	RE-WT001A	Water Trap- Adult/Pediatric, 57mm, 10pcs/Box;	
		9200-10-10574	RE-WT001N	Water Trap- Neonate, 47mm, 10pcs/Box;	

Medical Temperature Probes

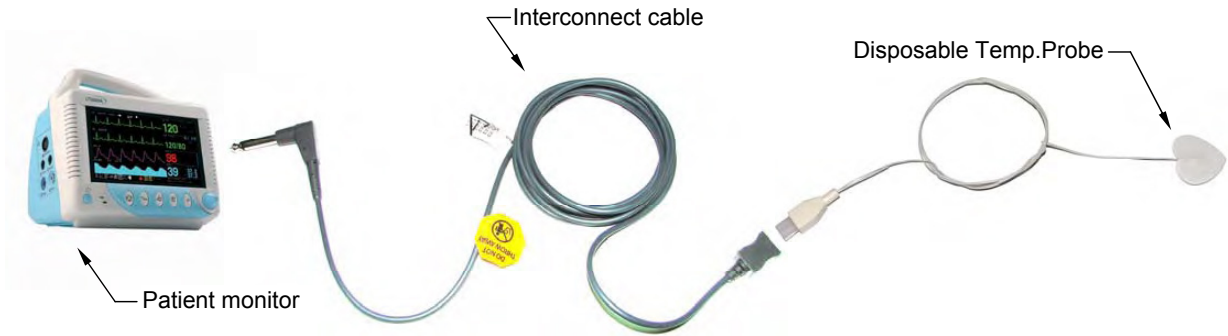

**Instrument Connector**



**Yoke type**

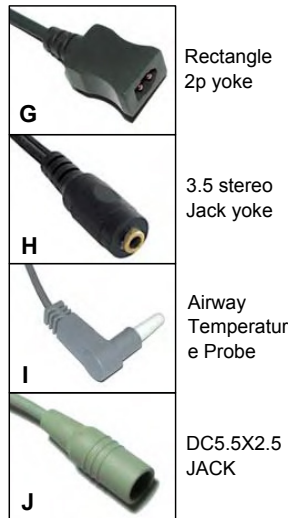

**Disposable temp. probe connector**



**Probe type and Code**

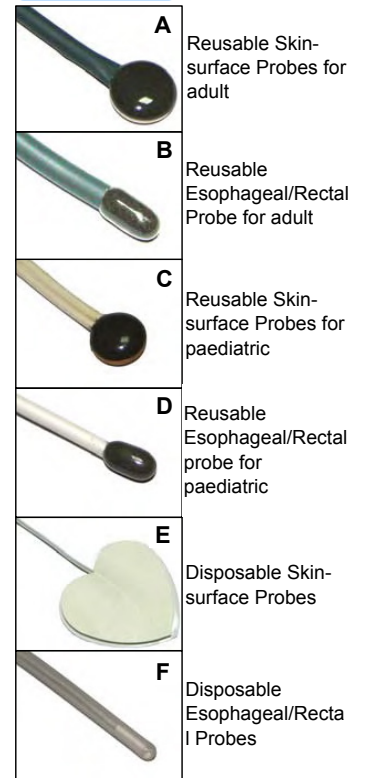

**Specifications**

Temperature Range: 0 to 50°C  
Accuracy: ±0.1°C from 25 to 45°C

- © Today's quality patient care requires body temperature monitor to be an integral part of any physiological measurements in the OR, ICU, CCU, or ER.MED-LINK offers a full line of reusable, sterilizable, temperature probes to measure body temperature on your critical patients.
- © Available in Rectal/Esophageal and Skin Surface Styles
- © Latex-free































Medical Temperature Probes

Compatible Brand	Compatible Models No.	OEM P/N	REF NO.	Description (Name,Length,Probes,Plug)	Instrument Connector or Probe connector	Yoke (probe side) or Probe type	
<b>YSI 400 Series</b> • Reusable temperature probes with Single Thermistors • Available in Rectal/Esophageal	<b>Philips</b> A3 series monitor Instrument: M3926A, M3927A, M3928A, M3929A; <b>Marquette</b> 7000/7010,GE Eagle, Solar, Tram, Tramscope, MAC-Lab Systems	409B	W0001A	Adult Reusable Skin-surface Probe, 10ft. (3.0 m), 25°C@2.25KΩ, φ6.3 mono plug>>φ12mm disk	053	365	
		401	W0001B	Adult Reusable Esophageal/Rectal Probe, 10ft. (3.0 m), 25°C@2.25KΩ, φ6.3 mono plug>>φ 4.7mm tip	053	367	
		427	W0001C	paediatric Reusable Skin-surface Probe, 10ft. (3.0 m), 25°C@2.25KΩ, φ6.3 mono plug>>φ5.6mm disk	053	366	
		402	W0001D	paediatric Reusable Esophageal/Rectal Probe, 10ft. (3.0 m), 25°C@2.25KΩ, φ6.3 mono plug>>φ 3.0mm tip	053	368	
		4499	W0001E	Disposable Skin-surface Probe, 0.8 m, 25°C@2.25KΩ, Rectangle 2pin>>Adhesive Pad Package:24pcs/pk	117		
		4491	W0001F	Adult Esophageal/Rectal Probe, 0.7 m, 25°C@2.25KΩ, Rectangle 2pin>>φ4.0mm tip Package:24pcs/pk	117		
		E9004ZS	W0001G	Temp. probe Interconnect Cable, 8 ft. (2.4M) , φ6.3 mono plug >> Rectangle 2pin, for use with Disposable Probes	053	274	
	Allows continuous temperature monitoring of gases delivered through anesthesia and respiratory circuits. Manifold outlet included with each probe.	441A	W0001I	Airway Temperature Probe, 10 ft. (3.0M) ,25°C@2.25KΩ, φ2.5 mono plug >> Type L probe, 7.6 mm diameter tapered manifold fitting	219	311	
	<b>YSI 700 Series</b> Reusable temperature probes with Dual Thermistors	<b>Spacelabs:</b> 90496 Module , compatible with Spacelabs P/N: 700-0031-00 <b>Marquette</b> 7000/7010,GE Eagle, Solar, Tram, Tramscope, MAC-Lab Systems, compatible with GEMS P/N:9445-001 <b>Mindray:</b> T8	709B	W0002A	Adult Reusable Skin-surface Probe, 10ft. (3.0 m), 25°C@6K/30KΩ, φ6.3 stereo plug>>φ12mm disk	054	365
				W0002D	paediatric Reusable Esophageal/Rectal Probe, 10ft. (3.0 m), 25°C@6K/30KΩ, φ6.3 stereo plug>>φ 3.0mm tip	054	368
			W0002C	paediatric Reusable Skin-surface Probe, 10ft. (3.0 m), 25°C@6K/30KΩ, φ6.3 stereo plug>>φ5.6mm disk	054	366	

Medical Temperature Probes



Compatible Brand	Compatible Models No.	OEM P/N	REF NO.	Description (Name,Length,Probes,Plug)	Instrument Connector or Probe connector	Yoke (probe side) or Probe type
<b>10K Series</b> • Reusable temperature probes with Single Thermistors • Available in Rectal/Esophageal	Suitable for China OEM patient monitor: <b>Tianrong</b> :TR900D/E; <b>Anke</b> :ASC553A3, ASC553; <b>Comon</b> : star 8000A/B/C, star 5000,5000B/C		W0004A	Adult Reusable Skin-surface Probe, 10ft, (3.0 m), 25°C@10KΩ, φ6.3 mono plug>>φ12mm disk	053 	365 
			W0004B	Adult Reusable Esophageal/Rectal Probe, 10ft, (3.0 m), 25°C@10KΩ, φ6.3 mono plug>>φ4.7mm tip	053 	367 
			W0004C	paediatric Reusable Skin-surface Probe, 10ft, (3.0 m), 25°C@10KΩ, φ6.3 mono plug>>φ5.6mm disk	053 	366 
			W0004D	paediatric Reusable Esophageal/Rectal Probe, 10ft, (3.0 m), 25°C@10KΩ, φ6.3 mono plug>>φ3.0mm tip	053 	368 
			W0004E	Disposable Skin-surface Probe, 0.8 m, 25°C@10KΩ, Rectangle 2pin>>Adhesive Pad Package:24pcs/pk	117 	
			W0004F	Adult Esophageal/Rectal Probe, 0.8 m, 25°C@10KΩ, Rectangle 2pin>>φ4.0mm tip Package:24pcs/pk	117 	
			E9004ZS W0001G	Temp. probe Interconnect Cable, 8 ft. (2.4M) , φ6.3 mono plug >> Rectangle 2pin, for use with Disposable Probes	053 	274 
	<b>Creative Shenzhen</b>	<b>Creative</b> patient monitor: PC-1000,5000,9000,UP-6000, 		W0005A	Adult Reusable Skin-surface Probe, 10ft, (3.0 m), 25°C@10KΩ, Readel 2p>>φ12mm disk	273 
			W0005B	Adult Reusable Esophageal/Rectal Probe, 10ft, (3.0 m), 25°C@10KΩ, Readel 2p>>φ4.7mm tip	273 	367 
<b>18B20 series</b>	Probes: DALLAS 18B20		W0006A	Adult Reusable Skin-surface Probe, 10ft, (3.0 m), 18B20, φ6.3 stereo plug>>φ12mm disk	054 	365 
			W0006B	Adult Reusable Esophageal/Rectal Probe, 10ft, (3.0 m), 18B20, φ6.3 stereo plug>>φ6.0mm tip	054 	367 



Medical Temperature Probes

www.bmtmedikal.com.tr

Compatible Brand	Compatible Models No.	OEM P/N	REF NO.	Description (Name,Length,Probes,Plug)	Instrument Connector or Probe connector	Yoke (probe side) or Probe type
<b>Ohmeda</b>			W0021C	paediatric Reusable Skin-surface Probe, 10ft. (3.0 m), 25°C@10KΩ, φ3.5 stereo plug>>φ5.6mm disk		
<b>Philips</b> • Reusable temperature probes with Single Thermistors • Available in Rectal/Esophageal	All Philips temperature monitors that accept two-prong plugs  	21078A	W0003A	Adult Reusable Skin-surface Probe, 10ft. (3.0 m), 25°C@2.25KΩ, 2pin plug>>φ12mm disk	051	365
		21075A	W0003B	Adult Reusable Esophageal/Rectal Probe, 10ft. (3.0 m), 25°C@2.25KΩ, 2 pin plug>>φ4.7mm tip	051	367
		21076A	W0003D	paediatric Reusable Esophageal/Rectal Probe, 10ft. (3.0 m), 25°C@2.25KΩ, 2pin plug>>φ3.0mm tip	051	368
		21091A	W0003E	Disposable Skin-surface Probe, 0.8 m, 25°C@2.25KΩ, 3.5 mono plug>>Adhesive Pad Package:24pcs/pk	369	
		21090A	W0003F	Adult Esophageal/Rectal Probe, 0.8 m, 25°C@2.25KΩ, 3.5 mono plug>>φ4.0mm tip Package:24pcs/pk	369	
			W0003G	Temp. probe Interconnect Cable, 8 ft. (2.4M) , 2 pin plug >> Rectangle 2pin, for use with Disposable Probes	051	274
		21082A	W0003H	Temp. probe Interconnect Cable, 8 ft. (2.4M) , 2pin plug >> φ3.5 Stereo jack, for use with Disposable Probes	051	275
<b>S&amp;W Artema</b> • Reusable temperature probes with Single Thermistors • Available in Rectal/Esophageal	DIASCOPE G2		W0007A	Adult Reusable Skin-surface Probe, 10ft. (3.0 m), 25°C@2.25KΩ, Round 10J>>φ12mm disk	276	365
			W0007B	Adult Reusable Esophageal/Rectal Probe, 10ft. (3.0 m), 25°C@2.25KΩ, Round 10J>>φ4.7mm tip	276	367
			W0007C	paediatric Reusable Skin-surface Probe, 10ft. (3.0 m), 25°C@2.25KΩ, Round 10J>>φ5.6mm disk	276	366
			W0007D	paediatric Reusable Esophageal/Rectal Probe, 10ft. (3.0 m), 25°C@2.25KΩ, Round 10J>>φ3.0mm tip	276	368
			W0007G	Temp. probe Interconnect Cable, 8 ft. (2.4M) , Round 10J>> Rectangle 2pin, for use with Disposable Probes	276	274
<b>Drager</b>	Infant Incubator/Radiant Warmer The reflective insulator serves as a barrier against ambient and radiant heat while allowing the most accurate sensing of the skin temperature.		W0020E	Disposable Skin-surface Probe, 0.8 m, 25°C@2.25KΩ, 2pin plug>>Adhesive Pad Package:24pcs/pk		BZ0109D Disposable probe pad price code: A2 /12pcs

Medical Temperature Probes



Compatible Brand	Compatible Models No.	OEM P/N	REF NO.	Description (Name,Length,Probes,Plug)	Instrument Connector or Probe connector	Yoke (probe side) or Probe type
<b>Siemens</b> • Reusable temperature probes with Single Thermistors • Available in Rectal/Esophageal	Siemens medical SC 6002XL, SC7000, SC8000, SC9000XL		W0008A	Adult Reusable Skin-surface Probe, 10ft, (3.0 m), 25°C@2.25KΩ, Round 7p>>φ12mm disk	266	365
			W0008B	Adult Reusable Esophageal/Rectal Probe, 10ft, (3.0m),25°C@2.25KΩ, Round 7p>>φ4.7mm tip	266	367
			W0008C	paediatric Reusable Skin-surface Probe, 10ft, (3.0 m), 25°C@2.25KΩ, Round 7p>>φ5.6mm disk	266	366
			W0008D	paediatric Reusable Esophageal/Rectal Probe, 10ft, (3.0m), 25°C@2.25KΩ, Round 7p>>φ3.0mm tip	266	368
			W0008G	Temp. probe Interconnect Cable, 8 ft. (2.4M) , 7p >> Rectangle 2pin, fit for disposable probes	266	274
<b>Specelabs Medical</b>	Spacelab : New modules 90651-08, 90496, Ultraview		W0022A	Adult Reusable Skin-surface Probe, 10ft, (3.0 m), 10pin>>φ12mm disk		365
			W0022B	Adult Reusable Esophageal/Rectal Probe, 10ft, (3.0m), 10pin>>φ4.7mm tip		367
<b>25°C@2.016KΩ</b> <b>O.S.7929</b>	<u>O.S.7929</u>	Ref.:092.059.600	W0009A	Adult Reusable Skin-surface Probe, 10ft, (3.0 m), 25°C@2.016KΩ, Din3p>>φ12mm disk	235	365
			W0009B	Adult Reusable Esophageal/Rectal Probe, 10ft, (3.0m),25°C@2.016KΩ, Din3p>>φ4.7mm tip	235	367
<b>Temp Sensor</b> <b>Cut Air Shields</b> <b>25°C@6.867KΩ</b> <b>C-100</b>	C-100 		W0010A	Adult Reusable Skin-surface Probe, 10ft, (3.0 m), 25°C@6.867KΩ, Din3p>>φ12mm disk	462	365
			W0010B	Adult Reusable Esophageal/Rectal Probe, 10ft, (3.0m),25°C@6.867KΩ, Din3p>>φ4.7mm tip	462	367
<b>Air Shields</b> <b>Versalet</b>	C2000		W0045K	Temp. probe Interconnect Cable, 2.2 ft. (0.67M) , MD5M >> ladder-shaped 4pin, fit for Drager disposable probes 4S and 4L		
			W0045C	Pediatric Skin-urface probe Length: 1.2M Resistance: 25°C 9/9KΩ		
<b>15K Series</b> • Reusable temperature probes with Single Thermistors • Available in Rectal/Esophageal			W0011B	Adult Reusable Esophageal/Rectal Probe, 10ft, (3.0m),25°C@15KΩ, φ 6.3 mono>>φ4.7mm tip	053	367



Medical Temperature Probes

Compatible Brand	Compatible Models No.	OEM P/N	REF NO.	Description (Name,Length,Probes,Plug)	Instrument Connector or Probe connector	Yoke (probe side) or Probe type	
Mindray  YSI 400 Series • Reusable temperature probes with Single Thermistors • Available in Rectal/Esophageal	PM6800 Series	0011-30-37393	W0013A	Adult Reusable Skin-surface Probe, 10ft, (3.0 m), 25°C@2.25KΩ, 2pin plug>>φ12mm disk	27	365	
		0011-30-37392	W0013B	Adult Reusable Esophageal/Rectal Probe, 10ft, (3.0 m), 25°C@2.25KΩ, 2pin plug>>φ4.7mm tip	277	367	
		0011-30-37395	W0013C	paediatric Reusable Skin-surface Probe, 10ft, (3.0 m), 25°C@2.25KΩ, 2pin plug>>φ5.6mm disk	277	366	
		0011-30-37394	W0013D	paediatric Reusable Esophageal/Rectal Probe, 10ft, (3.0 m), 25°C@2.25KΩ, 2pin plug>>φ3.0mm tip	277	368	
		0011-30-37391	W0013E	Disposable Skin-surface Probe, 0.8 m, 25°C@2.25KΩ, DC5.5x2.5 plug>>Adhesive Pad Package:24pcs/pk	278		
		0011-30-3790439	W0013F	Adult Esophageal/Rectal Probe, 0.8 m, 25°C@2.25KΩ, DC5.5x2.5 plug>>φ4.0mm tip Package:24pcs/pk	278		
	Mindray all module, except PM6800 Series		0011-30-90438	W0013J	Temp. probe Interconnect Cable, 8 ft. (2.4M) , 2pin plug >> DC5.5x2.5Jack, for use with Disposable Probes	277	279
				W0013G	Temp. probe Interconnect Cable, 8 ft. (2.4M) , 2pin plug >> Rectangle 2pin, for use with Disposable Probes	277	274
			0011-30-90434	W0001A	Adult Reusable Skin-surface Probe, 10ft, (3.0 m), 25°C@2.25KΩ, φ6.3 mono plug>>φ12mm disk	053	365
			0011-30-90432	W0001B	Adult Reusable Esophageal/Rectal Probe, 10ft, (3.0 m), 25°C@2.25KΩ, φ6.3 mono plug>>φ4.7mm tip	053	367
			0011-30-90435	W0001C	paediatric Reusable Skin-surface Probe, 10ft, (3.0 m), 25°C@2.25KΩ, φ6.3 mono plug>>φ5.6mm disk	053	366
			0011-30-90433	W0001D	paediatric Reusable Esophageal/Rectal Probe, 10ft, (3.0 m), 25°C@2.25KΩ, φ6.3 mono plug>>φ3.0mm tip	053	368
			0011-30-90436	W0014J	Temp. probe Interconnect Cable, 8 ft. (2.4M) , φ6.3 mono plug >> DC5.5x2.5Jack, for use with Disposable Probes	053	279
	GE Eagle Tram, Solar Monitors,MAC-Lab Cath Lab System		402015-004 E9004ZM	W0015A	Dual Temperature Cable, 8 in., Accepts YSI 400 or 700 Series Probes	427	428
<ul style="list-style-type: none"> <li>• Capability to select 400 or 700 Series directly on the cable</li> <li>• Cables can accommodate two temperature probes simultaneously</li> <li>• Latex-free</li> </ul>							

## Instrument Connector and Socket

### Electrocardiograph Connector

<p><b>CT0056B</b> FUKUDA EKG Price: B0</p> <p>Lock type DB15M, Gray, Plastic Fit Cable Diameter: Φ6.0</p>	<p><b>CT0056A</b> FUKUDA EKG Price: B0</p> <p>Lock type DB15M, Gray, Plastic Fit Cable Diameter: Φ6.0</p>	<p><b>CT0057M</b> Mortala EKG Price: B0</p> <p>Lock type DB15M, Gray, Plastic Fit Cable Diameter: Φ6.0</p>	<p><b>CT0076A</b> Siemens EKG Price: B0</p> <p>Lock type DB15M, Gray, Plastic Fit Cable Diameter: Φ6.0</p>	<p><b>CT0036A</b> Siemens EKG Price: A0</p> <p>Screw type DB15M, Gray, Metal Fit Cable Diameter: Φ6.0</p>
<p><b>CT0050A</b> MOQ:50PCS PETAS EKG Price: B0</p> <p>Screw type Round 12pin, Black, Metal, Fit Cable Diameter: Φ6.0</p>	<p><b>CT0112A</b> RMS EKG Price: A0</p> <p>Screw type DB25M, Gray, Plastic Fit Cable Diameter: Φ6.0</p>	<p><b>CT0058Q</b> Mortala EKG Price: B0</p> <p>Round 12pin, yellow, Plastic Fit Cable Diameter: Φ6.0</p>	<p><b>CT0071A</b> Medtronic EKG Price: B0</p> <p>Round 12pin, Green, Plastic Fit Cable Diameter: Φ6.0</p>	

### Patient monitor Connector for ECG

<p><b>CT0038A</b> General ECG Price: B2</p> <p>AMP Round 6pin, Black, Plastic Fit Cable Diameter: Φ5.0</p>	<p><b>CT0057A</b> Philips ECG Price: B2</p> <p>Round 12pin, White, Plastic, Fit Cable Diameter: Φ5.0</p>	<p><b>CT0057B</b> Kontron ECG Price: B2</p> <p>Round 12pin, Green, Plastic Fit Cable Diameter: Φ5.0</p>	<p><b>CT0057C</b> Datex ECG Price: B2</p> <p>Locking type round 10J, Blue, Plastic, Fit Cable Diameter: Φ5.0</p>	<p><b>CT0057D</b> NihonKonden ECG Price: B2</p> <p>Round 8pin, Black, Plastic Fit Cable Diameter: Φ5.0</p>
<p><b>CT0057E</b> Drager ECG Price: B2</p> <p>Round 10pin, White, Plastic, Fit Cable Diameter: Φ5.0</p>	<p><b>CT0057F</b> Bionet ECG Price: B2</p> <p>Locking type 8pin, Red, Plastic Fit Cable Diameter: Φ5.0</p>	<p><b>CT0057G</b> GEMS ECG Price: B2</p> <p>AMP Round 5pin, Black, Plastic Fit Cable Diameter: Φ5.0</p>	<p><b>CT0057H</b> Mennen ECG Price: B2</p> <p>Round 10pin, White, Plastic Fit Cable Diameter: Φ5.0</p>	<p><b>CT0057I</b> NK TEC-7621C ECG Price: B2</p> <p>Round 11pin, Black, Plastic Fit Cable Diameter: Φ5.0</p>
<p><b>CT0057J</b> PETAS ECG Price: B0</p> <p>Screw type Din-5pin, Black, Metal, Fit Cable Diameter: Φ5.0</p>	<p><b>CT0057K</b> PETAS ECG Price: A5</p> <p>Stereo 6.3 Plug, black, Plastic Fit Cable Diameter: Φ5.0</p>	<p><b>CT0002A</b> Criticare ECG Price: A5</p> <p>PAG 1Rrib 6-pin, Green, Plastic Fit Cable Diameter: Φ5.0</p>	<p><b>CT0014C</b> Novamatrix ECG Price: B2</p> <p>Locking type 7pin, Black, Plastic Fit Cable Diameter: Φ5.0</p>	<p><b>CT0057K</b> NK TEC-7621K ECG Price: B2</p> <p>Round 11pin, Black, Plastic Fit Cable Diameter: Φ5.0</p>
<p><b>CT0077A</b> GEMS ECG Price: B2</p> <p>Lock 6pin, Black, Plastic Fit Cable Diameter: Φ5.0</p>	<p><b>CT0090A</b> GEMS ECG Price: B2</p> <p>Rectangle 11pin, Green, Plastic Fit Cable Diameter: Φ5.0</p>	<p><b>CT0113A</b> MOQ:50PCS MEK ECG Price: A5</p> <p>Mini din 8pin, Black, Plastic Fit Cable Diameter: Φ5.0</p>	<p><b>CT0057Q</b> Artema ECG Price: B2</p> <p>Locking type round 10J, Blue, Plastic, Fit Cable Diameter: Φ5.0</p>	<p><b>CT0101A</b> Lohmeier ECG Price: B2</p> <p>Round 5pin+5Jack, White, Plastic Fit Cable Diameter: Φ5.0</p>

### Patient monitor Connector for IBP

<p><b>CT0044</b> Chenwie IBP Price: A5</p> <p>PAG 1Rrib-5pin, Red, Plastic Fit Cable Diameter: Φ5.0</p>	<p><b>CT0105A</b> Choice IBP Price: A5</p> <p>PAG 1Rrib-6pin, Red, Plastic Fit Cable Diameter: Φ5.0</p>	<p><b>CT0085C</b> Marquette IBP Price: B2</p> <p>Rectangle 11pin, Red, Plastic Fit Cable Diameter: Φ5.0</p>	<p><b>CT0078A</b> Philips IBP Price: B2</p> <p>Round 12pin, Red, Plastic Fit Cable Diameter: Φ5.0</p>	<p><b>CT0102A</b> MOQ:50PCS Philips IBP Price: B2</p> <p>Round 10pin, White, Plastic, Fit Cable Diameter: Φ5.0</p>
<p><b>CT0103A</b> Spacelabs IBP Price: B2</p> <p>AMP Round 6pin, Black, Plastic Fit Cable Diameter: Φ5.0</p>	<p><b>CT0058L</b> Datex IBP Price: B2</p> <p>Locking type round 10J, White, Plastic, Fit Cable Diameter: Φ5.0</p>	<p><b>CT0100A</b> Mennen IBP Price: B2</p> <p>Locking type 8pin, Red, Plastic Fit Cable Diameter: Φ5.0</p>	<p><b>CT0076B</b> Siemens IBP Price: B0</p> <p>Lock type DB15M, Gray, Plastic Fit Cable Diameter: Φ5.0</p>	<p><b>CT0104A</b> BD IBP Price: A5</p> <p>Round 7pin, White, Plastic Fit Cable Diameter: Φ5.0</p>

Instrument Connector and Socket

Patient monitor Connector for SpO2 and Holter





<p><b>CT0001A</b> Mindray SpO2 Price: A5</p>  <p>PAG 1Rib 5-pin, Blue, Plastic Fit Cable Diameter: Φ4.0</p>	<p><b>CT0106A</b> CSI RADO SpO2 Price: A5</p>  <p>MOQ:30PCS PAG 1Rib 6-pin, Blue, Plastic Fit Cable Diameter: Φ4.0</p>	<p><b>CT0009A</b> BCI SpO2 Price: A5</p>  <p>PAG 1Rib 7-pin, Blue, Plastic Fit Cable Diameter: Φ4.0</p>	<p><b>CT0003A</b> Mindray SpO2 Price: A5</p>  <p>PAA 2Rib 40° 6-pin, Blue, Plastic Fit Cable Diameter: Φ4.0</p>	<p><b>CT0008A</b> Goldway SpO2 Price: A5</p>  <p>PAA 2Rib 40° 7-pin, Blue, Plastic Fit Cable Diameter: Φ4.0</p>
<p><b>CT0017 (Original)</b> Medilog Holter Price: B1</p>  <p>MOQ:50PCS PAG 1Rib 14-pin, Green, Plastic Fit Cable Diameter: Φ5.0</p>	<p><b>CT0011D</b> Brentwood Holter Price: B1</p>  <p>FGG 0B 7-pin, Grey, metal Fit Cable Diameter: Φ5.0</p>	<p><b>CT0099A</b> Brentwood Holter Price: B2</p>  <p>MOQ:50PCS FGG 0B 10-pin, Grey, metal Fit Cable Diameter: Φ5.0</p>	<p><b>CT0018B</b> Mennen SpO2 Price: C2</p>  <p>MOQ:50PCS FGG 2B 10-pin, Blue, metal Fit Cable Diameter: Φ4.0</p>	<p><b>CT0043A (Original)</b> Drager SpO2 Price: F0</p>  <p>FGY 2B 8-pin, White, Plastic Fit Cable Diameter: Φ4.0</p>
<p><b>CT0010A</b> CSI SpO2 Price: B1</p>  <p>FGG 1B 5-pin, Blue, metal Fit Cable Diameter: Φ4.0</p>	<p><b>CT0010C</b> NONIN SpO2 Price: B1</p>  <p>FGG 1B 6-pin, Blue, metal Fit Cable Diameter: Φ4.0</p>	<p><b>CT0011A</b> INVIVO SpO2 Price: B1</p>  <p>FGG 1B 7-pin, Blue, metal Fit Cable Diameter: Φ4.0</p>	<p><b>CT0018</b> Landcom Holter Price: B1</p>  <p>FGG 1B 10-pin, Blue, metal Fit Cable Diameter: Φ4.0</p>	<p><b>CT0034D</b> Schiller SpO2 Price: A5</p>  <p>Din 7-pin, Black, Plastic Fit Cable Diameter: Φ4.0</p>
<p><b>CT0014A</b> Novamatrix SpO2 Price: B2</p>  <p>Hye 7-pin, Black, Plastic Fit Cable Diameter: Φ4.0</p>	<p><b>CT0013A</b> Simed SpO2 Price: B2</p>  <p>MOQ:30PCS Hye 9-pin, Black, Plastic Fit Cable Diameter: Φ4.0</p>	<p><b>CT0015A</b> Spacelabs SpO2 Price: B2</p>  <p>Hye 9-pin, Black, Plastic Fit Cable Diameter: Φ4.0</p>	<p><b>CT0058A</b> Bruker SpO2 Price: B2</p>  <p>Round 12-pin, Blue, Plastic Fit Cable Diameter: Φ4.0</p>	<p><b>CT0034A</b> Datascop SpO2 Price: A5</p>  <p>Din 8-pin, Black, Plastic Fit Cable Diameter: Φ4.0</p>
<p><b>CT0058B</b> Datex SpO2 Price: B2</p>  <p>MOQ:50PCS Round 10J, White, Plastic Fit Cable Diameter: Φ4.0</p>	<p><b>CT0058E</b> Philips SpO2 Price: B2</p>  <p>Round 12-pin, Blue, Plastic Fit Cable Diameter: Φ4.0</p>	<p><b>CT0058F</b> Nihon Konden SpO2 Price: B2</p>  <p>Round 10-pin, Blue, Plastic Fit Cable Diameter: Φ4.0</p>	<p><b>CT0058C</b> S&amp;W SpO2 Price: B2</p>  <p>Round 10J, Purple, Plastic Fit Cable Diameter: Φ4.0</p>	<p><b>CT0058M</b> Siemens SpO2 Price: B2</p>  <p>Round 6pin, Black, Plastic Fit Cable Diameter: Φ4.0</p>
<p><b>CT0058N</b> Bionet SpO2 Price: B2</p>  <p>MOQ:30PCS Round 6pin 30°, Black, Plastic Fit Cable Diameter: Φ4.0</p>	<p><b>CT0058D</b> Palco SpO2 Price: A5</p>  <p>RJ11 6P6C, Gray, Plastic Fit Cable Diameter: Φ4.0</p>	<p><b>CT0058H</b> Mennen SpO2 Price: B2</p>  <p>MOQ: 30PCS Round 8-pin, Blue, Plastic Fit Cable Diameter: Φ4.0</p>	<p><b>CT0035A</b> Pace Tech SpO2 Price: B2</p>  <p>Karon 5J, Black, Metal Fit Cable Diameter: Φ4.0</p>	<p><b>CT0020A</b> Masmo SpO2 Price: A5</p>  <p>HD14-pin, Gray, Plastic Fit Cable Diameter: Φ4.0</p>
<p><b>CT0020C</b> Nellcor SpO2 Price: B2</p>  <p>HD14-pin, 1 bit Gray, Plastic Fit Cable Diameter: Φ5.0</p>	<p><b>CT0020D</b> Nellcor SpO2 Price: B2</p>  <p>HD14-pin, 1 bit, Blue, Plastic Fit Cable Diameter: Φ5.0</p>	<p><b>CT0058I</b> Ohmeda SpO2 Price: B2</p>  <p>Locking 8P, Blue, Plastic Fit Cable Diameter: Φ4.0</p>	<p><b>CT0058J</b> Ohmeda SpO2 Price: B2</p>  <p>Locking 8J, Blue, Plastic Fit Cable Diameter: Φ4.0</p>	<p><b>CT0058K</b> Masmo SpO2 Price: B2</p>  <p>Quick Lock 6-pin, White, Plastic Fit Cable Diameter: Φ4.0</p>
<p><b>CT0058R</b> Masmo SpO2 Price: B2</p>  <p>Quick Lock 6J, White, Plastic Fit Cable Diameter: Φ4.0</p>	<p><b>CT0107A</b> Nellcor SpO2 Price: A5</p>  <p>DB9pin Male, Gray, Plastic Fit Cable Diameter: Φ4.0</p>	<p><b>CT0065B</b> GEMS-Dash Price: B2</p>  <p>Rectangle 11pin, Blue, Plastic Fit Cable Diameter: Φ4.0</p>	<p><b>CT0085A</b> GEMS-Masmo Price: B2</p>  <p>Rectangle 11pin, Blue, Plastic Fit Cable Diameter: Φ4.0</p>	<p><b>CT0003E (Original)</b> Mindray SpO2 Price: A9</p>  <p>PAB 2Rib 60° 6-pin, White, Plastic Fit Cable Diameter: Φ4.0</p>
<p><b>CT0092A (Original)</b> Mindray SpO2 Price: A9</p>  <p>PAC 2Rib 80° 6-pin, White, Plastic Fit Cable Diameter: Φ4.0</p>	<p><b>CT0003F</b> Choice SpO2 Price: B1</p>  <p>PAG 1Rib 9-pin, Blue, Plastic Fit Cable Diameter: Φ4.0</p>	<p><b>CT0062A</b> Price: A5</p>  <p><b>CT0062B</b> Price: A5</p>  <p>M12 1Rib 2-pin, Black, Metal Fit Cable Diameter: Φ5.0</p>	<p><b>CT0065A</b> Price: A5</p>  <p><b>CT0065B</b> Price: A5</p>  <p>M12 1Rib 8-pin, Black, Metal Fit Cable Diameter: Φ5.0</p>	

## Instrument Connector and Socket

### Patient Monitor Socket

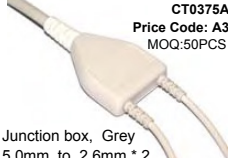
 <p><b>E0001B</b> Mindray ECG Price: F0/box 20pcs/box</p> <p>Round 6-pin socket, Black, Plastic, Flange: 30X30cm</p>	 <p><b>E0001G</b> Mindray ECG Price: F0/box 20pcs/box</p> <p>Round 6-pin socket, Black, Plastic, Flange: 23.5X23.5cm</p>	 <p><b>E0001D</b> Mindray IBP Price: F0/box 20pcs/box</p> <p>AMP Round 6-pin socket, Red, Plastic, Flange: 30X30cm</p>	 <p><b>E0001F</b> Mindray IBP Price: F0/box 20pcs/box</p> <p>AMP Round 6-pin socket, Red, Plastic, Flange: 23.5X23.5cm</p>	 <p><b>E0001O</b> GEMS ECG Price: F0/box 20pcs/box</p> <p>AMP Round 5-pin socket, Grey, Plastic, Flange: 30X30cm MOQ:100PC</p>	
 <p><b>E0001P</b> Siemens SpO2 Price: F0/box 20pcs/box</p> <p>AMP Round 6-pin socket, Grey, Plastic, Flange: 30X30cm MOQ:100PC</p>	 <p><b>CT0108A</b> Mindray ECG Price: A6</p> <p>Round 12-pin socket, Green, Plastic, Flange: 30X30cm MOQ:50PCS</p>	 <p><b>CT0109A</b> Mindray SpO2 Price: A6</p> <p>Round 12-pin socket, Blue, Plastic, Flange: 30X30cm MOQ:50PCS</p>	 <p><b>CT0110A</b> Mindray IBP Price: A6</p> <p>Round 12-pin socket, Red, Plastic, Flange: 30X30cm MOQ:50PCS</p>	 <p><b>CT0001B</b> Mindray SpO2 Price: A5</p> <p>PKG 1-bit 5Jack Socket, Blue, Plastic</p>	
 <p><b>CT0002B</b> CSI RADO SpO2 Price: A5</p> <p>PKG 1-bit 6Jack Socket, Blue, Plastic</p>	 <p><b>CT0009B</b> BCI SpO2 Price: A5</p> <p>PKG 1-bit 7Jack Socket, Blue, Plastic</p>	 <p><b>CT0003G</b> Choice SpO2 Price: B1</p> <p>PKG 1-bit 9Jack Socket, Blue, Plastic</p>	 <p><b>CT0017B</b> Medilog Holter Price: B1</p> <p>PKG 1-bit 14Jack Socket, Grey, Plastic</p>	 <p><b>CT0044B</b> Chenwie IBP Price: A5</p> <p>PKG 1-bit 4Jack Socket, Grey, Plastic</p>	
 <p><b>CT0003B</b> Mindray SpO2 Price: A5</p> <p>PKA 2Rib 40° 6-pin, Socket Blue, Plastic</p>	 <p><b>CT0008B</b> Goldway SpO2 Price: A5</p> <p>PKA 2Rib 40° 7-pin, Socket Blue, Plastic</p>	 <p><b>CT0011C</b> Brentwood Holter Price: B1</p> <p>EGG 0B 7Jack, socket, metal</p>	 <p><b>CT0099B</b> Brentwood Holter Price: B1</p> <p>EGG 0B, 10Jack, socket ,metal MOQ:50PCS</p>	 <p><b>CT0010D</b> CSI SpO2 Price: B1</p> <p>EGG 1B, 5Jack, socket,</p>	
 <p><b>CT0010E</b> NONIN SpO2 Price: B1</p> <p>EGG 1B, 6Jack, socket, metal</p>	 <p><b>CT0011E</b> INVIVO SpO2 Price: B1</p> <p>EGG 1B, 7Jack, socket, metal</p>	 <p><b>CT0081A</b> Landcom Holter Price: B1</p> <p>EGG 1B, 10Jack, socket, metal</p>	 <p><b>CT0068A</b> YSI 400 TEMP Price: A1</p> <p>6.3 mm Stereo socket Black, Plastic</p>		
<p>Din1.5mm single socket, (Diffent colour can be choosed: Black,Brown, Red, Orange, Yellow, Green, Blue, Purple, Grey, White), Price Code: A1</p>	 <p><b>CT0068G</b></p>	 <p><b>CT0068K</b></p>	 <p><b>CT0068B</b></p>	 <p><b>CT0068L</b></p>	 <p><b>CT0068D</b></p>
	 <p><b>CT0068E</b></p>	 <p><b>CT0068F</b></p>	 <p><b>CT0068H</b></p>	 <p><b>CT0068I</b></p>	 <p><b>CT0068J</b></p>
<p>Din1.5mm single straight socket, (Diffent colour can be choosed: Black,Brown, Red, Orange, Yellow, Green, Blue, Purple, Grey, White), Price Code: A1</p>	 <p><b>CT0111A</b></p>	 <p><b>CT0111C</b></p>	 <p><b>CT0111E</b></p>	 <p><b>CT0111G</b></p>	 <p><b>CT0111J</b></p>
	 <p><b>CT0111B</b></p>	 <p><b>CT0111D</b></p>	 <p><b>CT0111F</b></p>	 <p><b>CT0111H</b></p>	 <p><b>CT0111K</b></p>

### Junction box (assembly)

 <p><b>CT0375A</b> Price Code: A3 MOQ:50PCS</p> <p>Junction box, Grey 5.0mm to 2.6mm * 2</p>	 <p><b>CT0376A</b> Price Code: A4 MOQ:100PC</p> <p>Junction box, Grey 5.0mm to 2.6mm * 3</p>	 <p><b>CT0377A</b> Price Code: A4 MOQ:50PCS</p> <p>Junction box, Grey 5.0mm to 2.6mm * 4</p>	 <p><b>CT0378A</b> Price Code: A4 MOQ:30PCS</p> <p>Junction box, Grey 5.0mm to 2.6mm * 5</p>	 <p><b>CT0379A</b> Price: A5 MOQ:30PCS</p> <p>Junction box, Grey 6.0mm to 3.25mm * 10</p>
---	---	---	---	--

EEG/EMG Leadwires with Electrodes

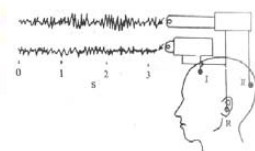

Instrument Connector



Patient termination or Electrodes



Socket

	Din1.0mm double socket, Diffent colour can be choosed: CT0254A(Black) 、 CT0254D(Orange) 、 CT0254C(Blue) 、 CT0254B(Yellow)		A2
See page 18-3	Din1.5mm single socket, ( Diffent colour can be choosed: Black,Brown,Red, Orange,Yellow,Green,Blue,Purple,Grey,White )		A1
See page 18-3	Din1.5mm single straight socket, ( Diffent colour can be choosed: Black,Brown,Red, Orange,Yellow,Green,Blue,Purple,Grey,White )		A1

EEG Lead wires with Electrodes

Med-link Ref No.	Description,Name,Connector, Color,Length	Instrument side	Patient side		
B143-T-BLA-60	Tooth type grabber EEG cord, 143>T, Black, L=60" (1.5 m) 5pcs/bag	143		T	
B143-T-RED-60	Tooth type grabber EEG cord, 143>T, RED, L=60" (1.5 m)				
B143-T-GRN-60	Tooth type grabber EEG cord, 143>T, Green, L=60" (1.5 m)				
B143-P-BLA-60	Cup Electrode EEG cord, 143>P, Black, L=60" (1.5 m) 5pcs/bag	143		P	
B143-P-RED-60	Cup Electrode EEG cord, 143>P, Red, L=60" (1.5 m) 5pcs/bag				
B143-P-GRN-60	Cup Electrode EEG cord, 143>P, Green, L=60" (1.5 m) 5pcs/bag				
B134-T-BLA-60	Tooth type grabber EEG cord, 134>T, Black, L=60" (1.5 m) 5pcs/bag	134		T	
B134-T-RED-60	Tooth type grabber EEG cord, 134>T, Red L=60" (1.5 m)				
B134-T-GRN-60	Tooth type grabber EEG cord, 134>T, Green, L=60" (1.5 m)				
B134-P-BLA-60	Cup electrode EEG cord, 134>P, Black, L=60" (1.5 m) 5pcs/bag	134		P	
B134-P-RED-60	Cup Electrode EEG cord, 134>P, Red L=60" (1.5 m) 5pcs/bag				
B134-P-GRN-60	Cup Electrode EEG cord, 134>P, Green, L=60" (1.5 m) 5pcs/bag				
B112-P-BLA-60	Cup Electrode EEG cord, 112>P, Black, L=60" (1.5 m) 5pcs/bag	112		P	
B708-P-BLA-45	Compatible Biomedical Instruments EEG lead wires, 12-Lead, Radiotransparent Leadwires, Cup electrode.				
CT0086A	EEG Electrode, Matal: Cu/AgCl ,10pcs/pk				
B143-P-10-48	EEG LEAD 10-WIRESET(48IN), KRYPTONITE				
B143-P-10-72	EEG LEAD 10-WIRESET(72IN), KRYPTONITE				
B143-P-10-96	EEG LEAD 10-WIRESET(96IN), KRYPTONITE				
B143-P-10-120	EEG LEAD 10-WIRESET(120IN), KRYPTONITE				

EMG Electrodes and cord



**EMG Lead wires with Electrodes**

Med-link Ref No.	Description,Name,Connector, Color,Length	Instrument side	Patient side
B143-N-BLA-60	Needle electrode EMG cord, 143>N, Black, L=60" (1.5 m) 5pcs/bag	143	N
B143-N-RED-60	Needle electrode EMG cord, 143>N, Red L=60" (1.5 m)		
B143-N-GRN-60	Needle electrode EMG cord, 143>N, Green, L=60" (1.5 m)		
B134-N-BLA-60	Needle electrode EMG cord, 134>N, Black, L=60" (1.5 m) 5pcs/bag	134	N
B134-N-RED-60	Needle electrode EMG cord, 134>N, Red, L=60" (1.5 m)		



Model: Nr. 15. 1-25, Nr. 15. 1-28,  
Nr. 15. 1-38, Nr. 15. 1-50,  
Nr. 15. 1-60,  
Name:EMG Needle  
Size:  
25mm, 28mm, 38mm, 50mm, 60mm,  
Price Code: B0



Connecting Cable  
Size: 1.2 m, 2 m  
Price Code: N9

**Lead Bead Markers**

Compatible Brand	Plug	REF NO.	Description (Name, Length, Patient end termination, Resistance,)
Lead Bead Markers Diameter range: 0.9mm~1.5mm		SL0373A	AAMI, 10pcs/pk, (RA,LA,RL,LL,V1,V2,V3,V4,V5,V6), Colour: White,Black,Green,Red,Red,Yellow,Green,Blue,Orange,Purple
		SL0373B	IEC, 10pcs/pk, (R,L,RF,F,C1,C2,C3,C4,C5,C6), Colour: Red,Yellow,Black,Green,Red,Yellow,Green,Brown,Black,Purple
		SL0373C	AAMI, 5pcs/pk, (Colour code: RA,LA,RL,LL,V), Colour: White,Black,Green,Red,Brown
		SL0373D	IEC, 5pcs/pk, (Colour code: R,L,RF,F,C), Colour: Red,Yellow,Black,Green,White)

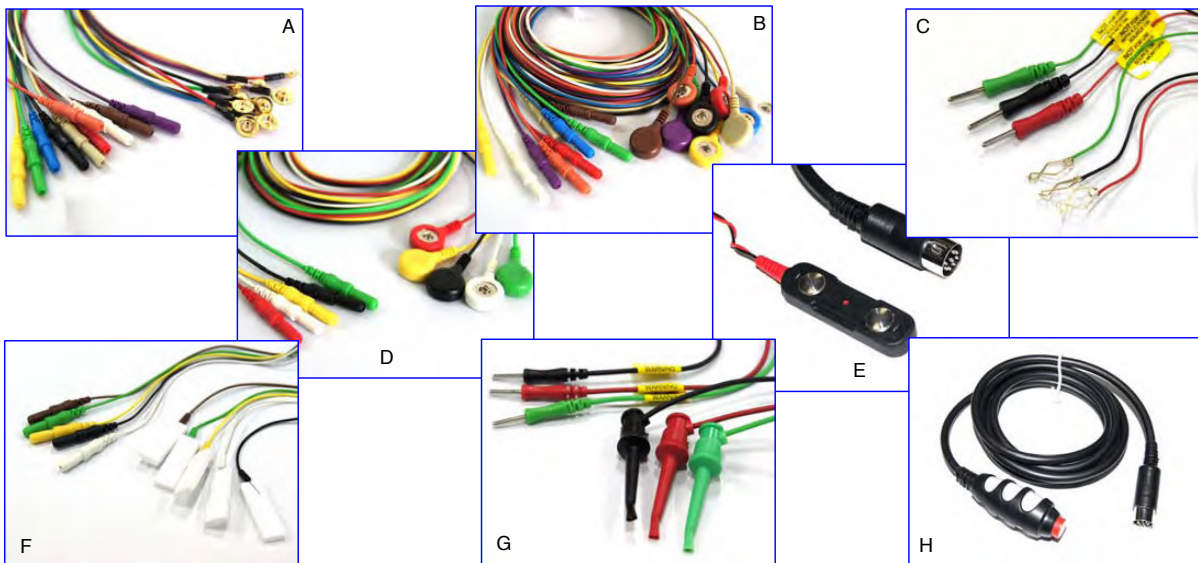

ESU pencil and Connecting cable for electrosurgery



Our company can provide customers with a variety of standard and custom high-frequency surgical instrument cables and electrodes (Disposable and Reusable)

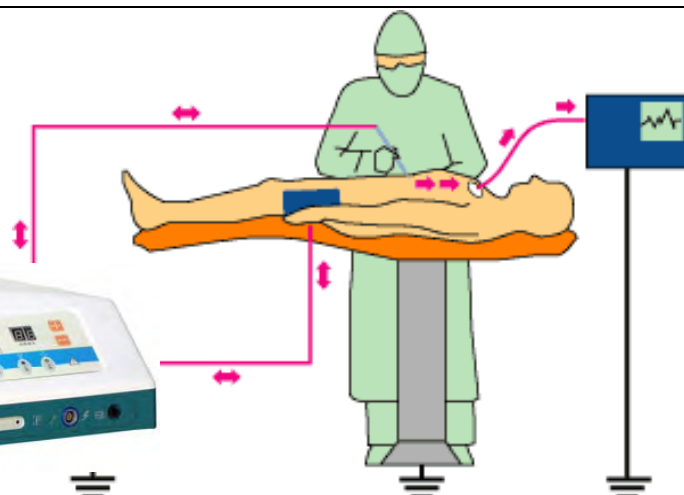

**Instrument connector**

**Active Electrode**

P351-148-13 Connecting cable for electrosurgery (Endoscope)



P296-315-10 Bipolar Electrode Cable(US)



P296-297-10 Bipolar Electrode Cable(EURO)



P283-284-10 Bipolar Electrode Cable(EURO)



P285-286-09 Disposable Electrosurgical pencil



P876-877-10 Reusable Foot Control Electrosurgical pencil



P913-287-03 Disposable ESU Patient Plate-Monopolar

P053-281-13 Patient Return Plate Cable

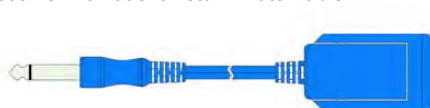

P913-288-03 Disposable ESU Patient Plate-Bipolar

P281-280-13 Patient Return Plate Cable

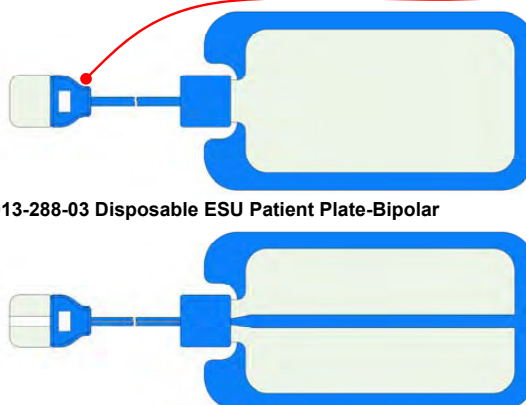

Preset 1m cables to avoid the plug stress patients, add adhesion flexibility, reduce the pollution which Reusable return cables impacted Operation Area, Jacket can prevent dropping and the liquid splash spilled.

Electrosurgical Accessories



**Patient Return Plate Cable and Grounding Pad**



280  
Model No: P281-280-13  
Description: Patient Return Plate Cable, L=13 ft.(4 m)  
Connector: 2.35 Jack to Plate-Bipolar Connector  
Price Code: A5



280  
Model No: P053-281-13  
Description: Patient Return Plate Cable, L=13 ft.(4 m)  
Connector: 6.3 Mono Plug to Plate-Bipolar Connector  
Price Code: A5



282  
Model No: P053-296-10  
Description: Patient Return Plate Cable, L=10 ft.(3 m)  
Connector: 6.35 Mono Plug to Banana plug  
Price Code: A5

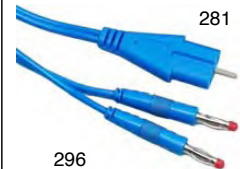

281  
Model No: P281-296-13  
Description: Patient Return Plate Cable, L=13 ft.(4 m)  
Connector: 2.35 Jack to Banana plug  
Price Code: A5



Model No: 287  
Description: Disposable Electrosurgical Patient Plate-Monopolar, Size: 200x105mm  
Price Code: A2



Model No: 288  
Description: Disposable Electrosurgical Patient Plate-Bipolar, Size: 200x105mm  
Price Code: A2

**Electrosurgical Pencil**



285  
Model No: P285-286-09  
Name: Disposable Electrosurgical pencil  
Description: Standard Blade Length=40mm; Length of wire: 9 ft (2.8m); Package way:200pcs/box;  
Price Code: A3

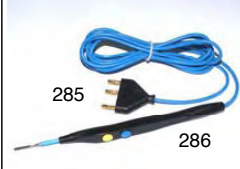

285  
Model No: P285-286-09-R  
Name: Reusable Electrosurgical pencil  
Description: Standard Blade Length=40mm; Length of wire: 9 ft (2.8m); Package way:1 piece/bag;  
Price Code: A0



Model No: P876-877-10  
Name: Reusable Foot Control Electrosurgical pencil  
Description:Standard Blade Length=40mm; Length of wire: 9 ft (2.8m); Package way:1 piece/bag;  
Price Code: A0 MOQ: 50PCS



**We can supply our customer with common active electrode and customize special active electrode according to their requirements.**

**Connecting cable for electrosurgery**



284  
Model No: P283-284-10  
Name: Bipolar Electrode Cable  
Description: L=10 ft. (3 m)  
2\*Banana Plug to Euro style con.  
Fit Euro style bipolar forceps  
Package way: 1 piece/bag;  
Price Code: A5

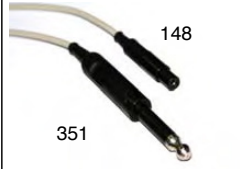

148  
Model No: P351-148-13  
Name: Connecting cable for electrosurgery (Endoscope)  
Original No.: 20192-117  
Description: L=13 ft, Connector type: 7.9 mono plug to 3.0 Jack.  
Price Code: A6



297  
Model No: P296-297-10  
Name: Bipolar Electrode Cable  
Description: Length: 10 ft. (3 m)  
2\*Banana Plug to Euro style con.  
Fit Euro style bipolar forceps  
Package:1 piece/bag;  
Price Code: A5

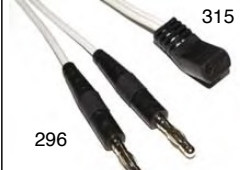

315  
Model No: P296-315-10  
Name: Bipolar Electrode Cable  
Description: Length: 10 ft. (3 m)  
2\*Banana Plug to US style con.  
Fit US style bipolar forceps  
Package:1 piece/bag;  
Price Code: A5

## Temp Pulse Oximeter



Directional screen switch



Oximeter extension cable



Adapter

### Specification

- \*Accuracy Range: (Arms) : 70~100% SpO2±3% digits
- \*Pulse Rate Declared Accuracy Range ( Arms) : 20~250 BPM
- \*Temperature accuracy: range:  $\pm 0.1^{\circ}\text{C}$  form 25°C to 45°C

### Features

- \*Three parameters : SpO2, Pulse Rate, Temperature
- \*Intended use: For family and medical environment;
- \*Strengths: Accurate, anti-movement algorithm, good performance during low perfusion, lower power consumption;
- \*Sensor types: Can connect different types of SpO2 probes and temp probes simultaneously or individually;
- \*Display mode: Dual-color OLED display(blue and yellow);
- \*Power Unit: Two 1.5V (AAA size) alkaline battery;
- \*Automatically power off function;
- \*Easy to use with one-key operation;
- \*Small in size, and easy to carry
- \*Light weight of 31g (No include batteries)

# TAMİR BAKIM ONARIM

## 0216 518 65 45-46

010101010001010100010100011010010011

01010101000101010001010100011010010011

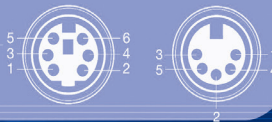

www.bmtmedikal.com.tr

**BMT Medikal olarak her marka ve model tıbbi cihazların teknik servis ve bakımı yapılır.**



\*Bu katalogta bahsedilen ürünler, logolar ve şirket isimleri başka firmaların ticari markaları olabilir. Bu durum yukarıda adı geçen markaların Bmt Medikal ile herhangi bir yakınlığı veya onayı olarak algılanmamalıdır. Bu dokümanda verilen bilgiler dikkatlice kontrol edilmiş ve doğruluğuna inanılmıştır. Sürekli ürün gelişimi adına, Bmt Medikal bu dokümanda ve tarif edilen üründe uyan ve bilgilendirme yapmadan değişiklikler ve gelişmeler yapma hakkını saklı tutar.

# TEKNİK HİZMETLER



## Ameliyathane

Anestezi Cihazları  
Ameliyat Masaları  
Ameliyat Lambaları  
Medikal Monitörler  
Aspirasyon-Irrigasyon Cihazları  
Genel Cerrahi Optikleri  
Ortopedik Motorlar, Genel Cerrahi Motorları  
Fiber Kablolar  
Elektrokoterler



## Yoğun Bakım

Ventilatör Cihazları  
Hasta Başı Monitörleri  
Ekg Cihazları  
Defibrilatör Cihazları  
Serum ve Şırınga Pompaları



## Genel

Soğuk Işık Kaynakları  
Elektronik Sedyeler  
Mekanik Sedyeler  
SpO2 Cihazları  
Hasta Yatakları  
Ördek- Sürgü Yıkama ve Dezenfeksiyon Cihazları  
Fetal Monitörler  
Capnograf

# sağlık'ta profesyonel adımlar...

# BİYOMEDİKAL DANIŞMANLIK



## Biomedical Therapy



### Tıbbi Cihaz Satın Alımı

Sağlık kuruluşu ve kullanıcı talepleri doğrultusunda piyasa araştırmaları yapılır. Firma, maliyet, teknik hizmetler ve kalite gibi özellikler değerlendirilerek uygun görülen cihazlar için teklifleri de içeren bir rapor hazırlanır. Cihazların demo çalışmaları organize edilir.

### Hastanelere Biyomedikal Departmanı Kurulumu

Hastanelerde Biyomedikal Departmanı kurulumu için ihtiyaç duyulacak personel, cihaz ve ekipmanların temini sağlanır. Departmanın dünya standartlarında çalışması için gerekli prosedürler oluşturulur.

### Biyomedikal Kalite Çalışmaları

Hastane genelinde alınması planlanan kalite belgesi doğrultusunda Biyomedikal Departmanı kalite prosedürlerinin oluşturulması, indikatörlerin belirlenmesi, ilgili form ve çizelgelerin hazırlanması faaliyetlerini kapsar.



\*Bu katalogta bahsedilen ürünler, logolar ve şirket isimleri başka firmaların ticari markaları olabilir. Bu durum yukarıda adı geçen markaların Bmt Medikal ile herhangi bir yakınlığı veya onayı olarak algılanmamalıdır. Bu dokümanda verilen bilgiler dikkatlice kontrol edilmiş ve doğruluđuna inanılmıştır. Sürekli ürün gelişimi adına, Bmt Medikal bu dokümanda ve tarif edilen üründe uyarı ve bilgilendirme yapmadan deđişiklikler ve gelişmeler yapma hakkını saklı tutar.



[www.bmtmedikal.com.tr](http://www.bmtmedikal.com.tr)



**BMT MEDİKAL SİST. VE ÜRÜNL. SAN. ve DIŞ TİC. LTD.ŞTİ.**  
Aydınevler Mah. İskele Sk. No:13/1 Maltepe-İstanbul - TURKEY  
Tel: 0216 518 65 45 - 46 Fax: 0216 518 65 47  
e-mail: [info@bmtmedical.com](mailto:info@bmtmedical.com) web: [www.bmtmedical.com](http://www.bmtmedical.com)